

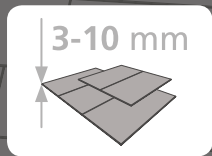

CVBL SRF

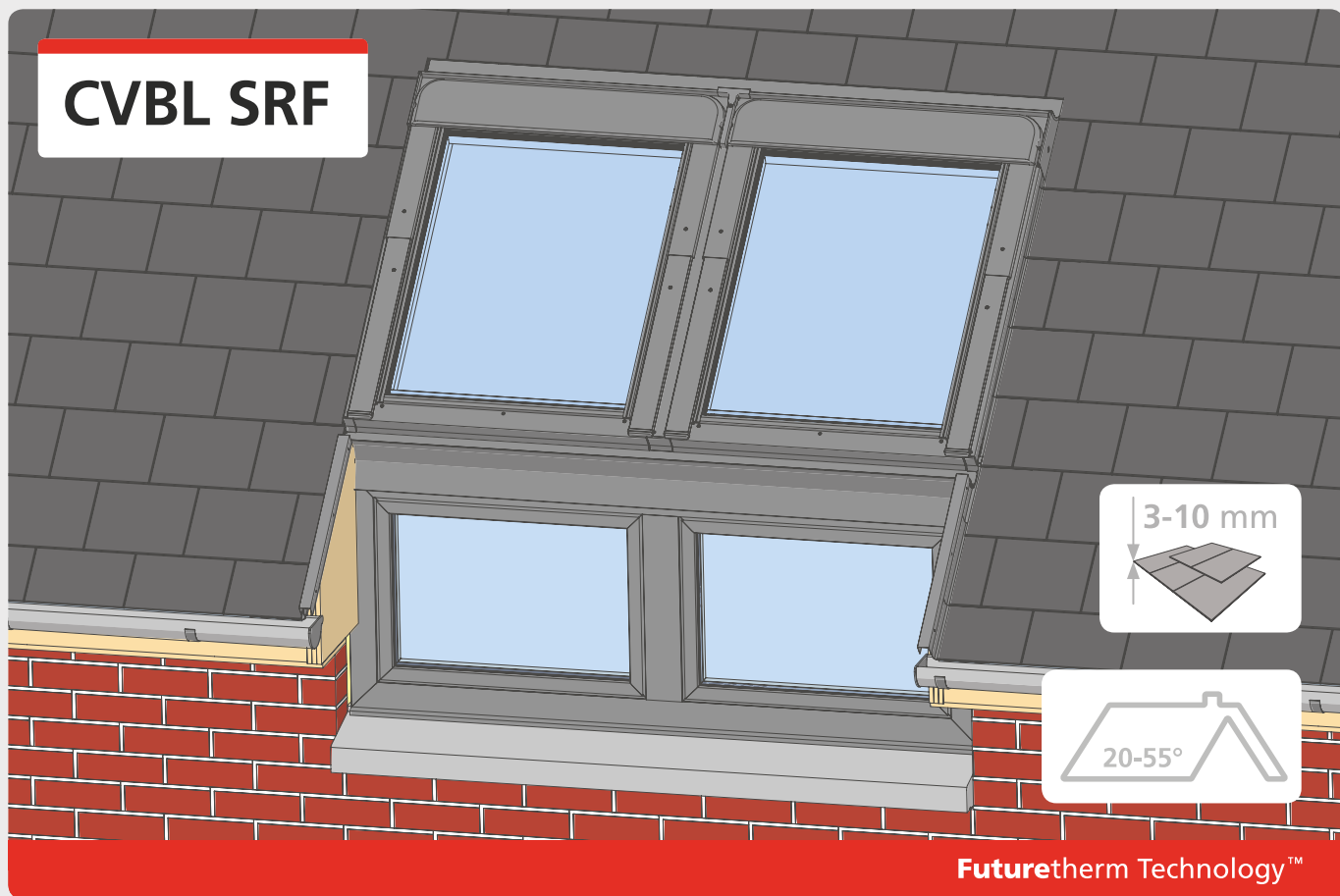

Futuretherm Technology™

- 2x
 - 2x
 - 2x
 - 1x
 - 1x
 - 1x
 - 1x
- 1x
- 4x - 8x
- 1x
- 4x - 8x
- 1x - 3x
- 1x
- 1x - 3x
- 1x
- 1x
- 1x
- 8x
- 1x
- 1x
- 1x

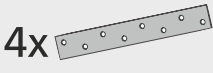
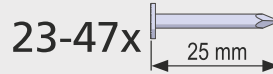
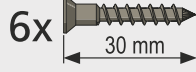
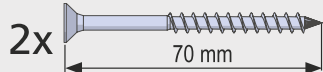

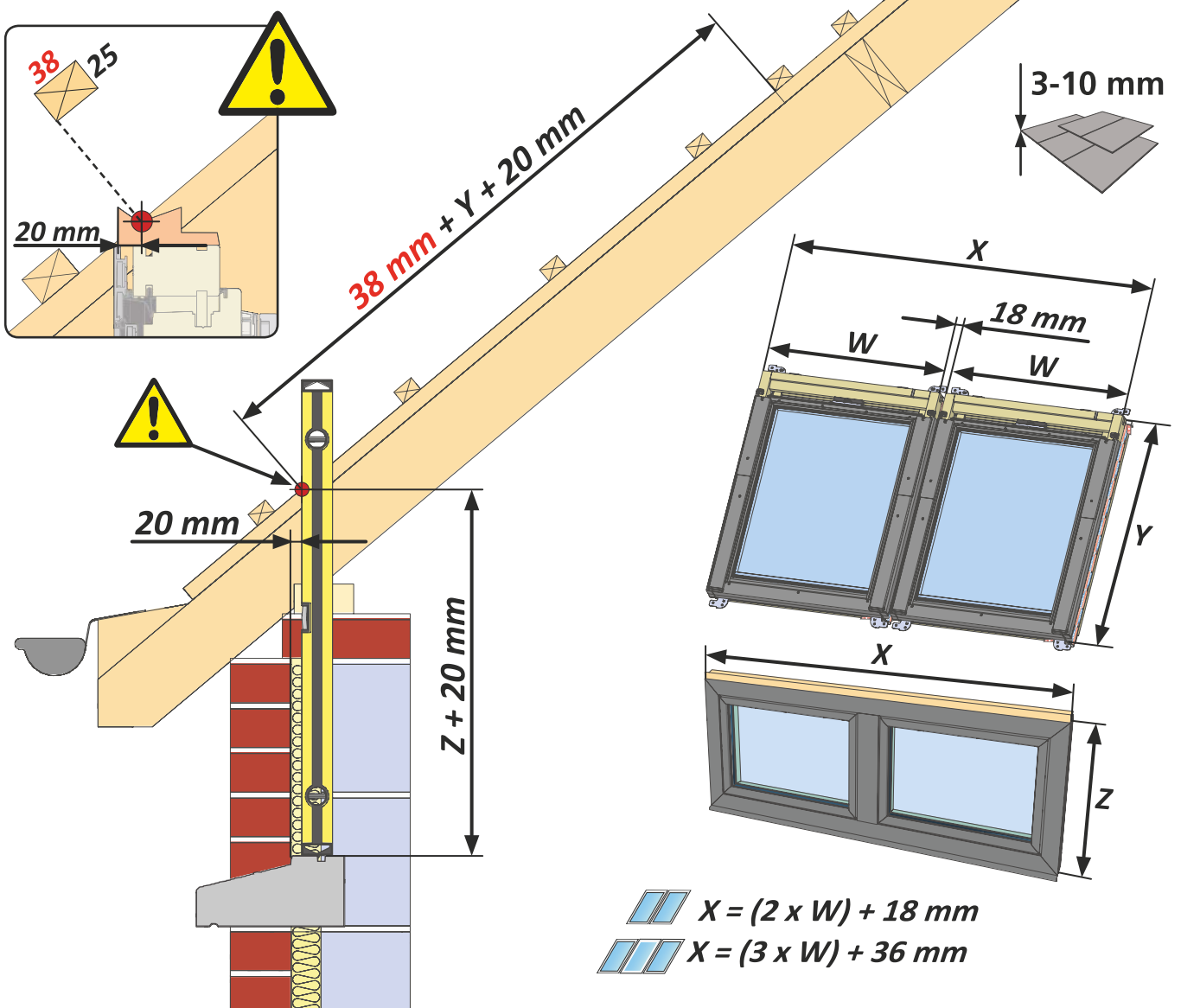
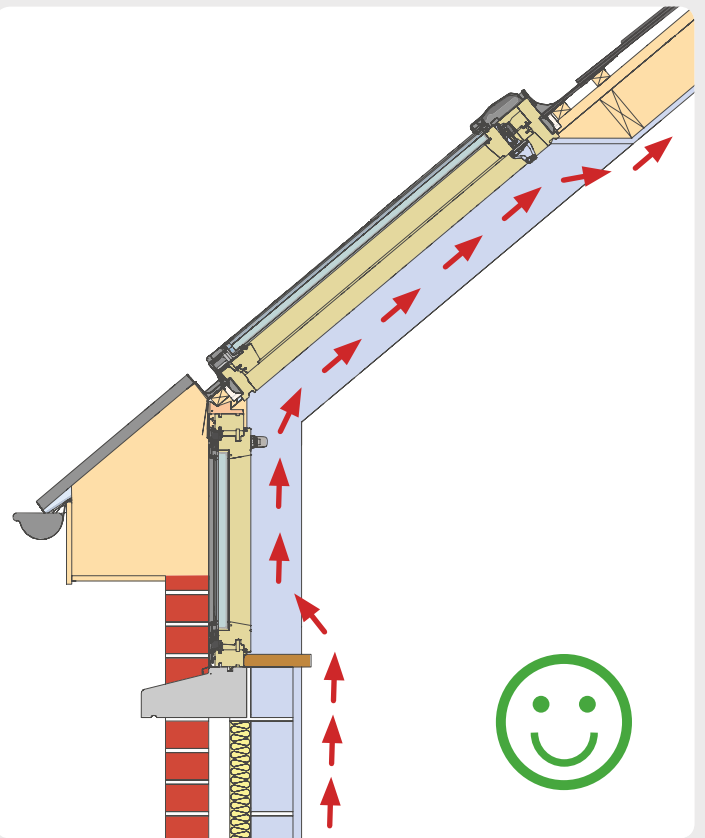
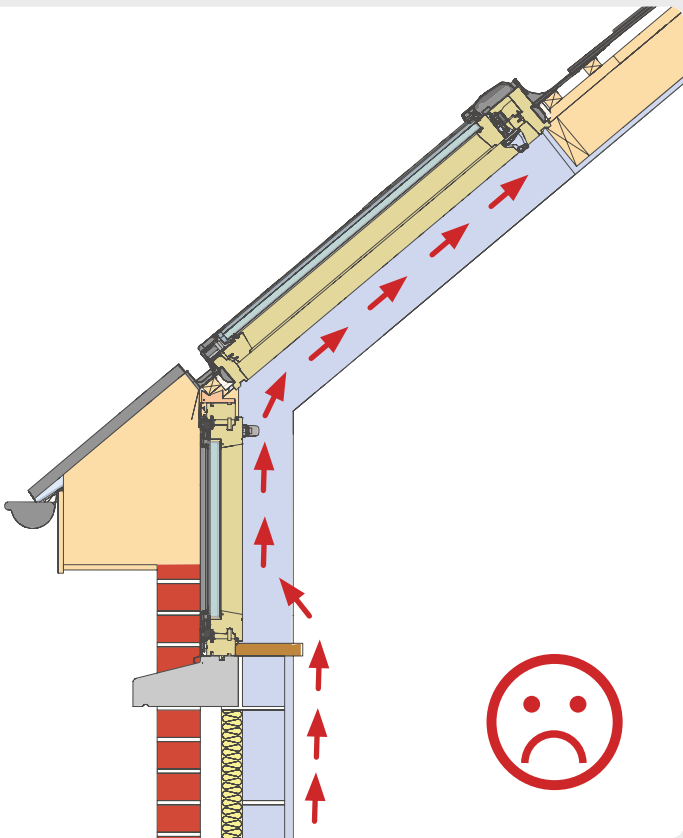

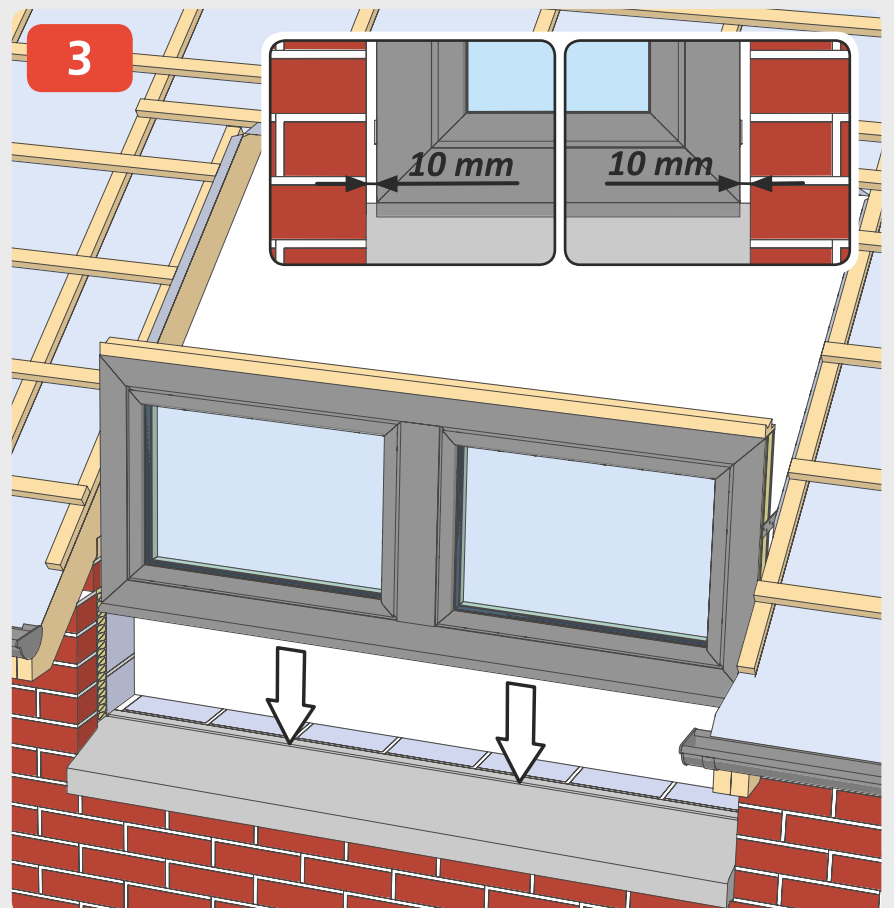
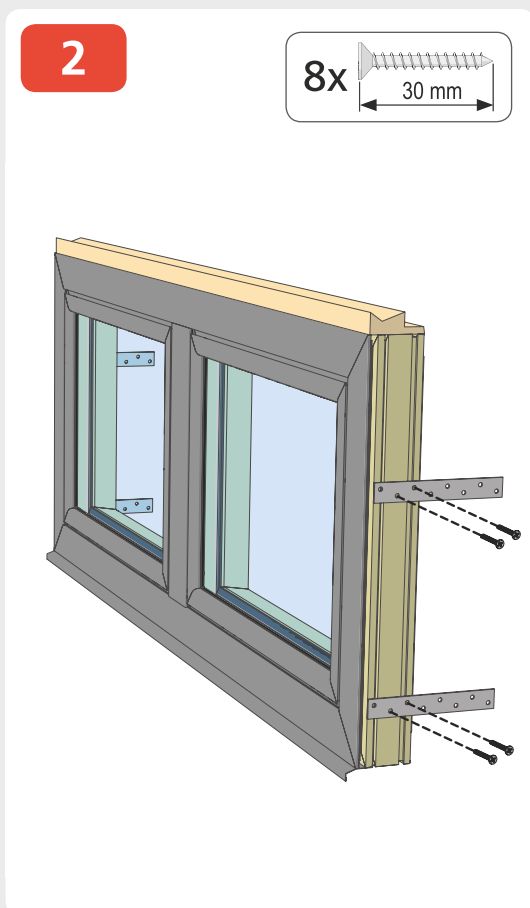
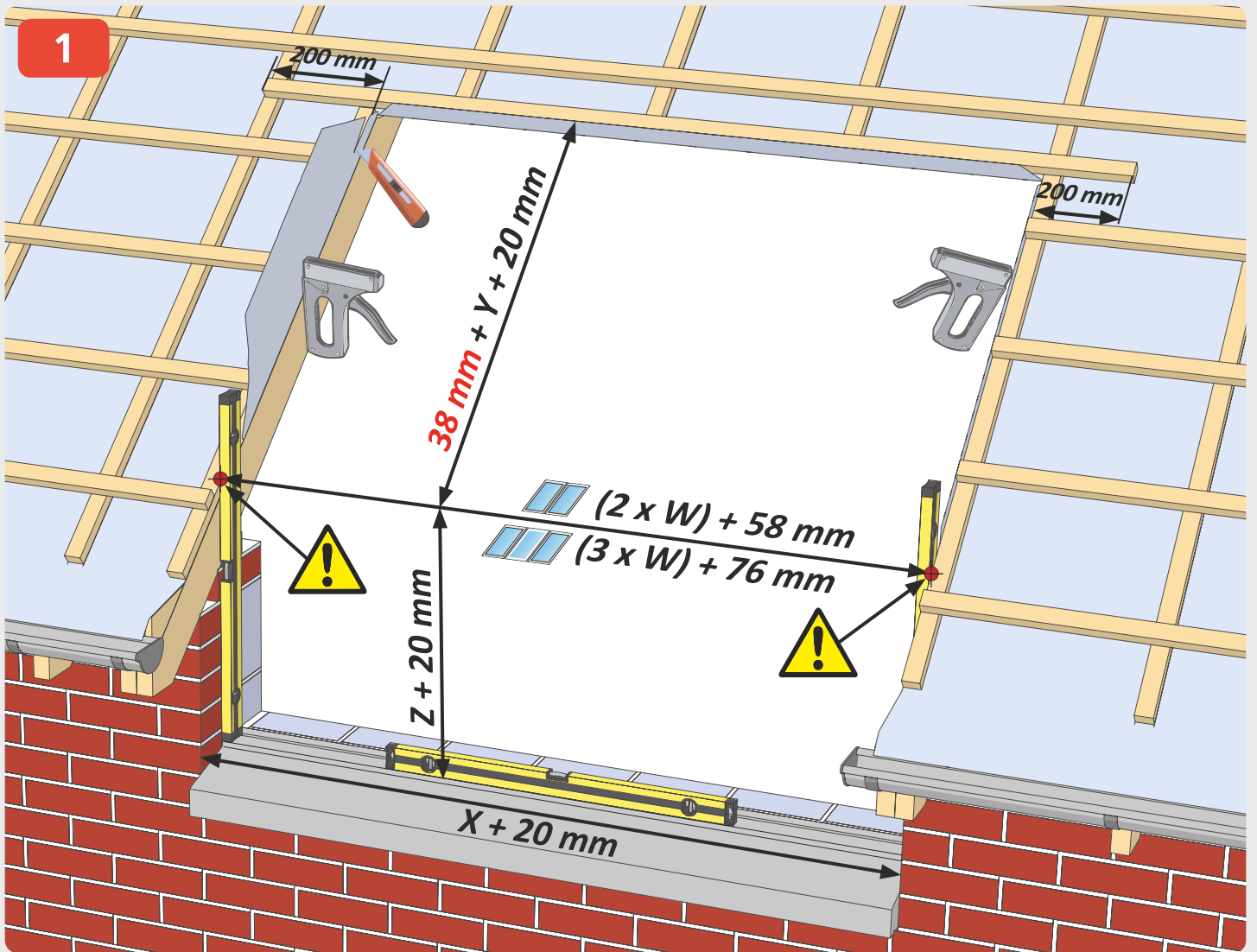

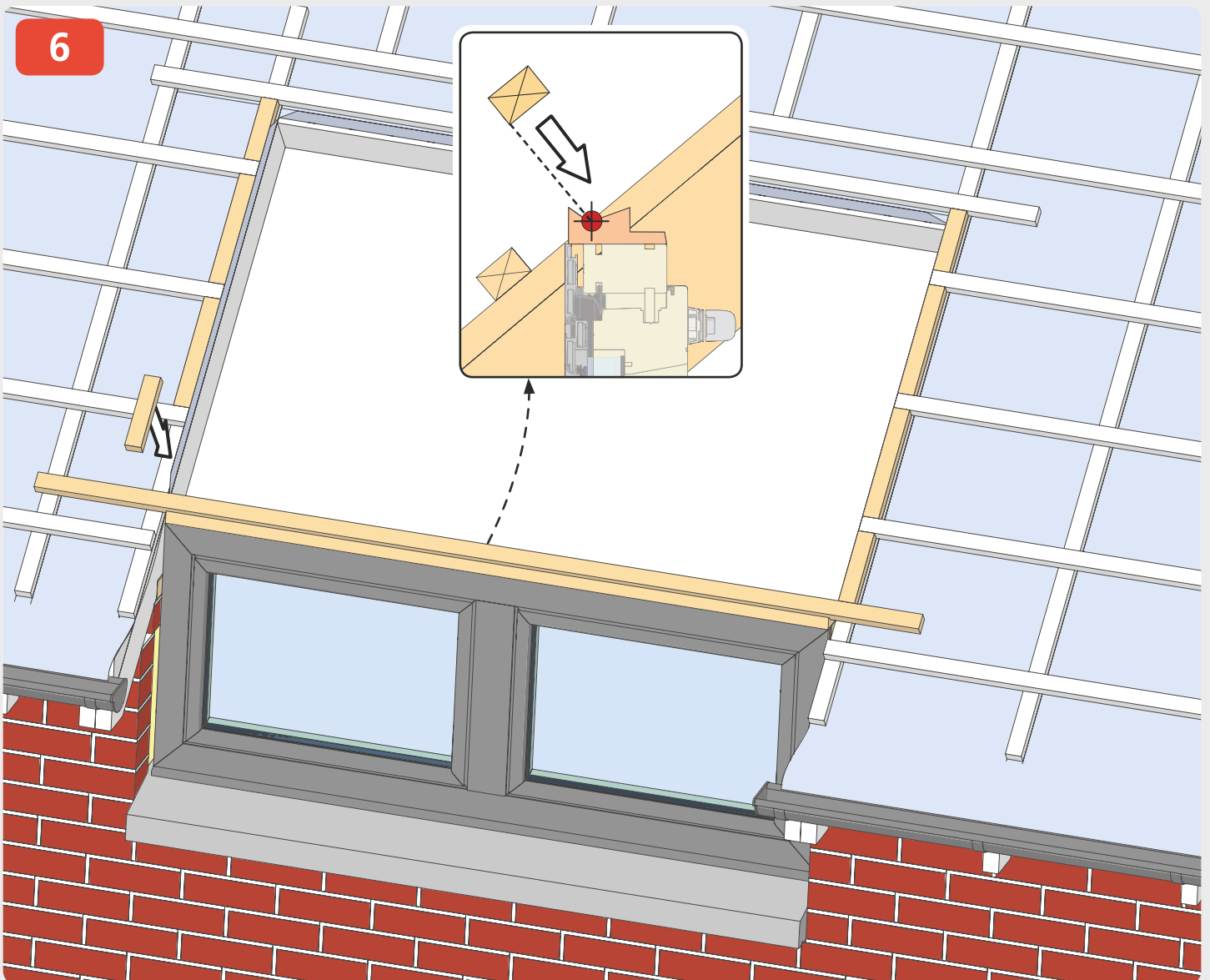
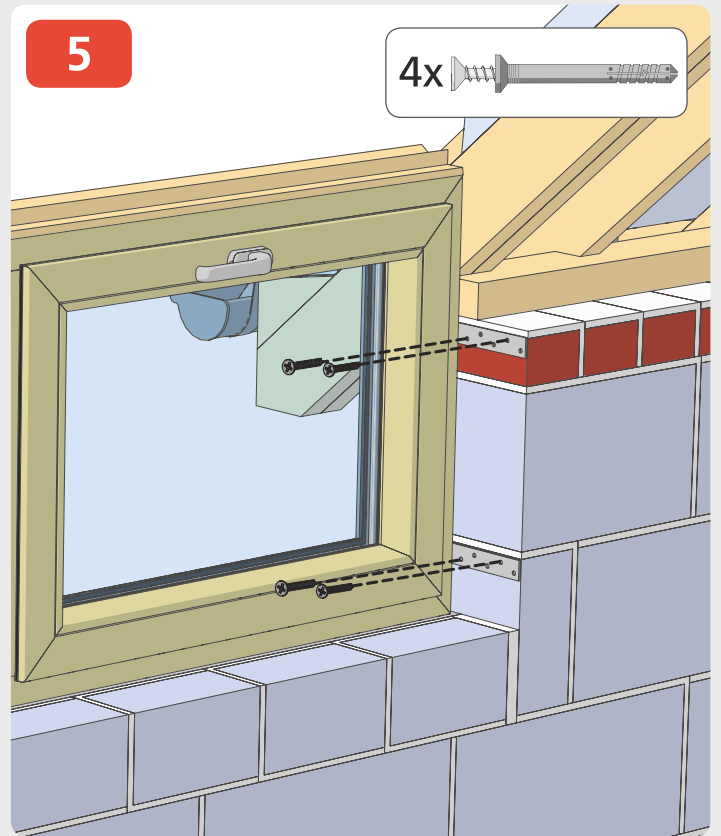
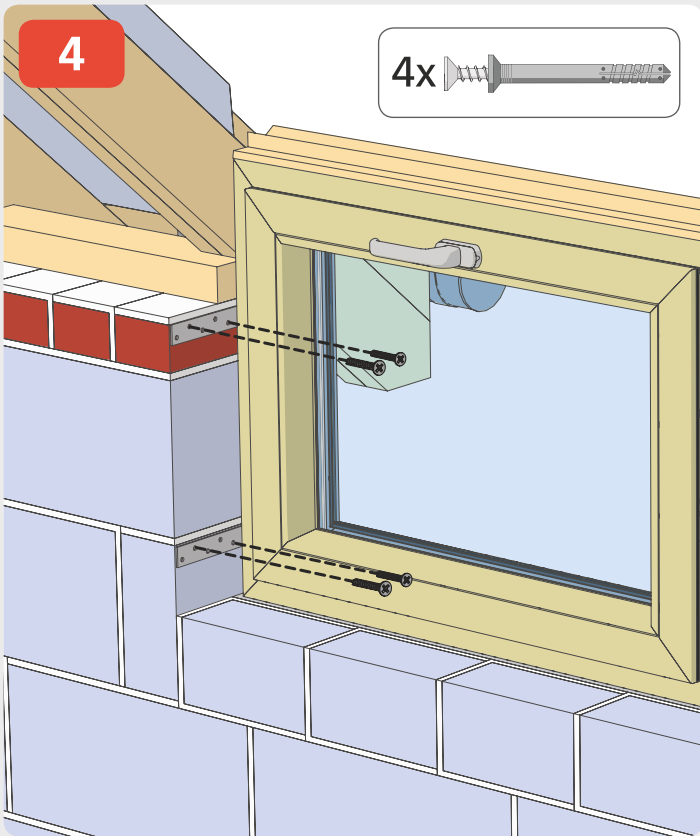

7a

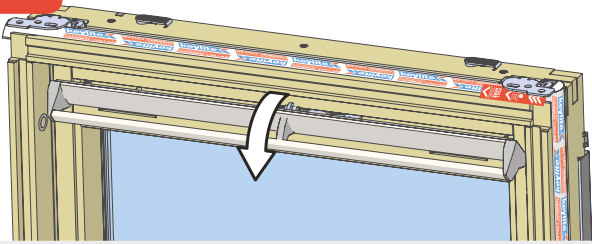

7b

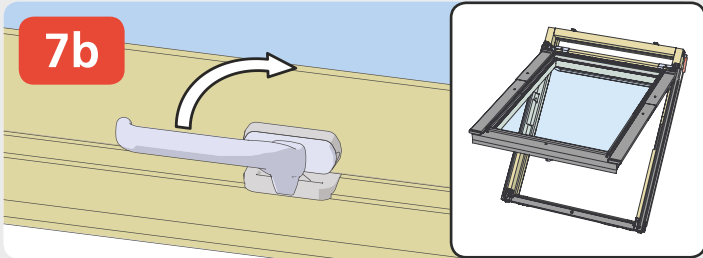

8

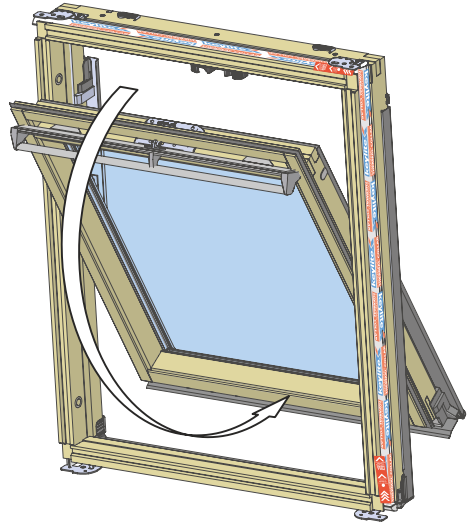

9

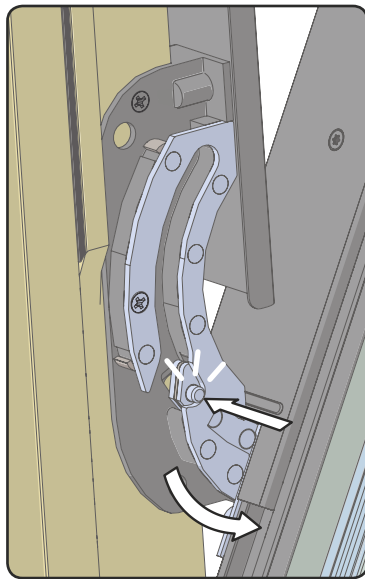
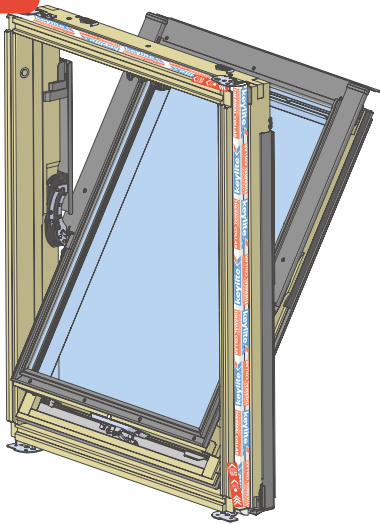

10

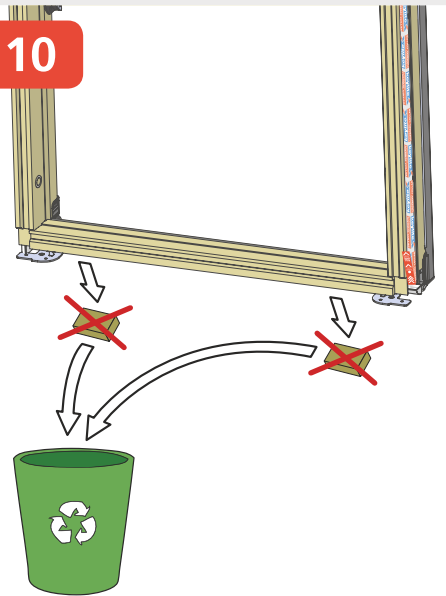

11

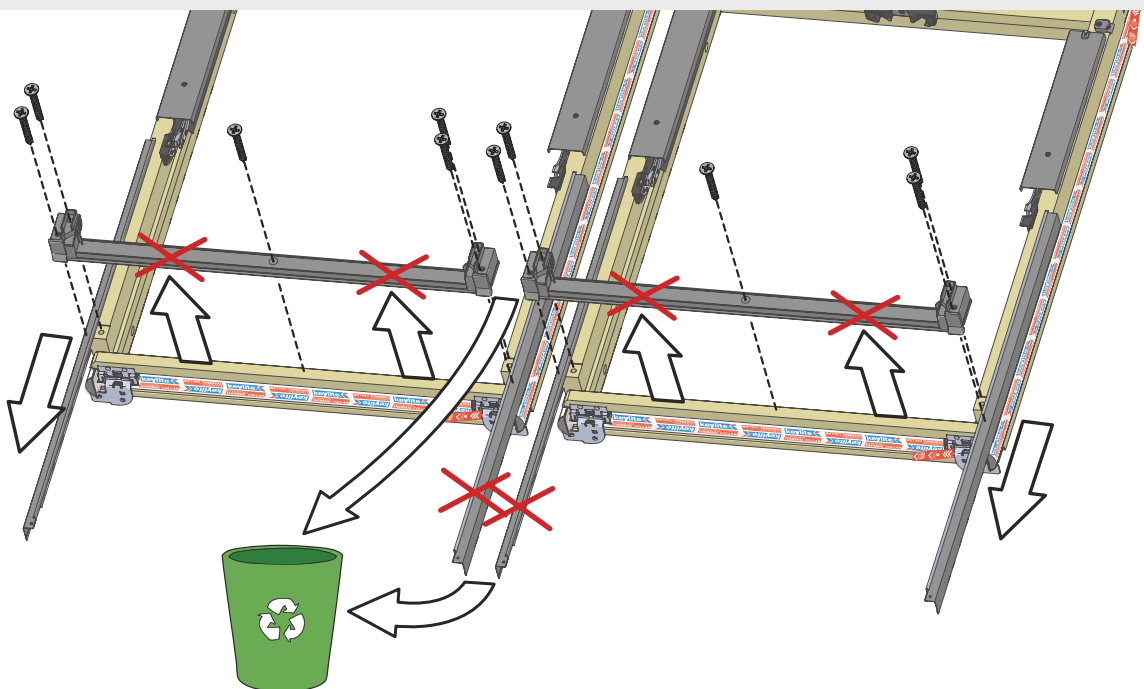

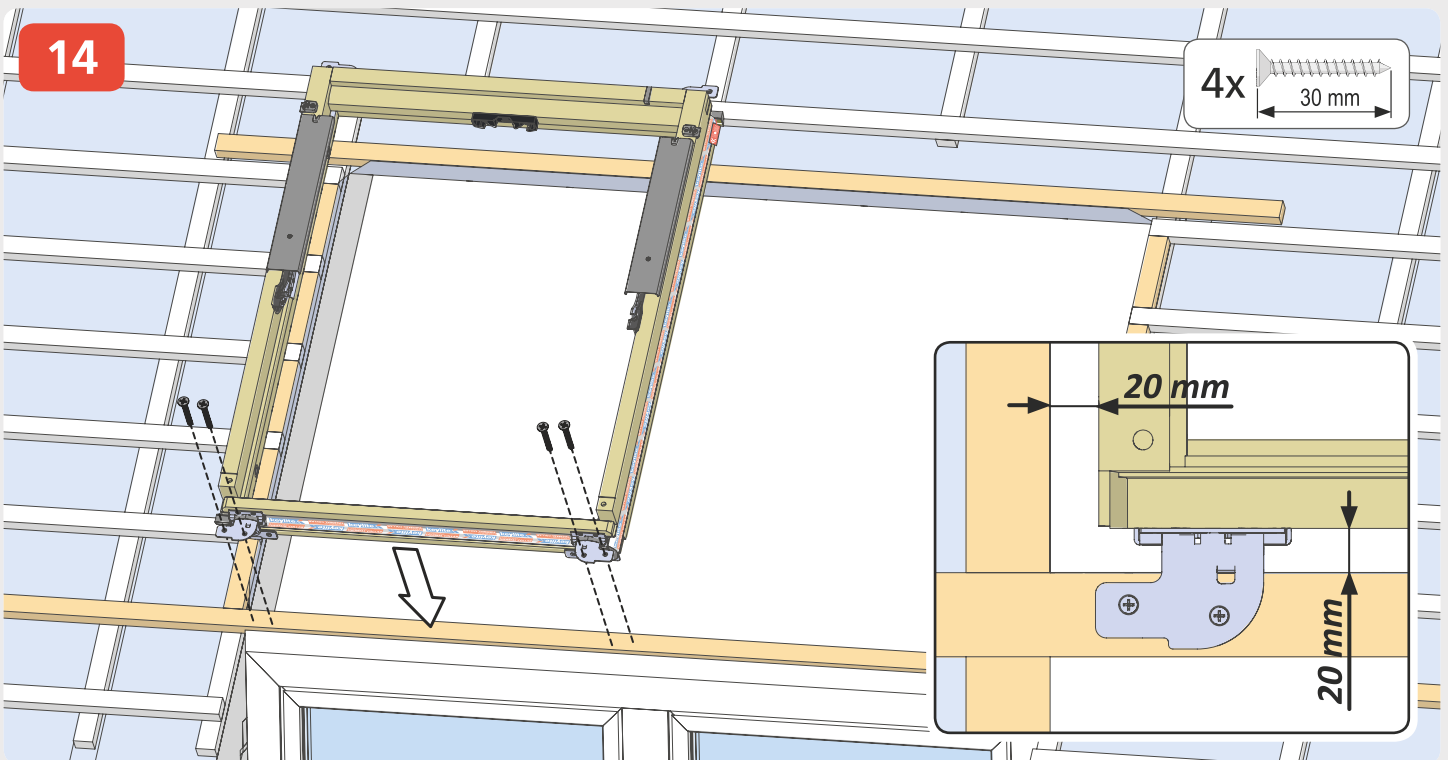
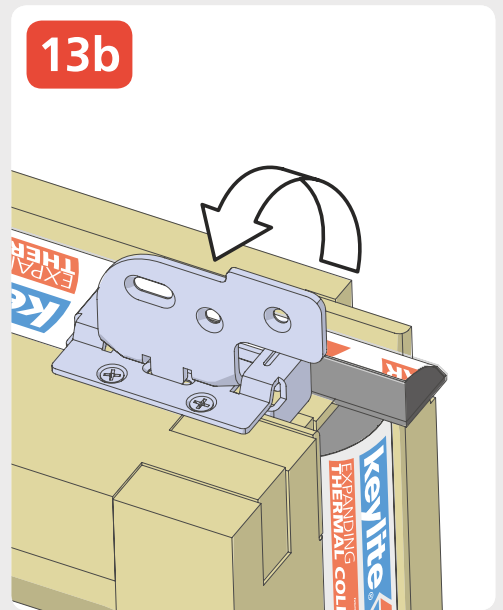
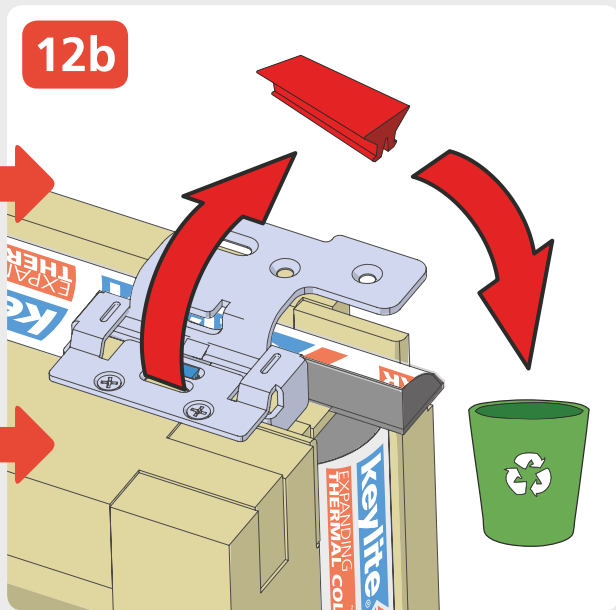
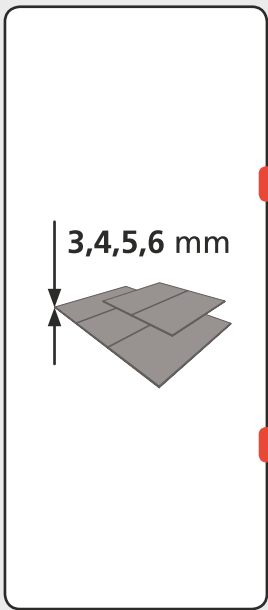
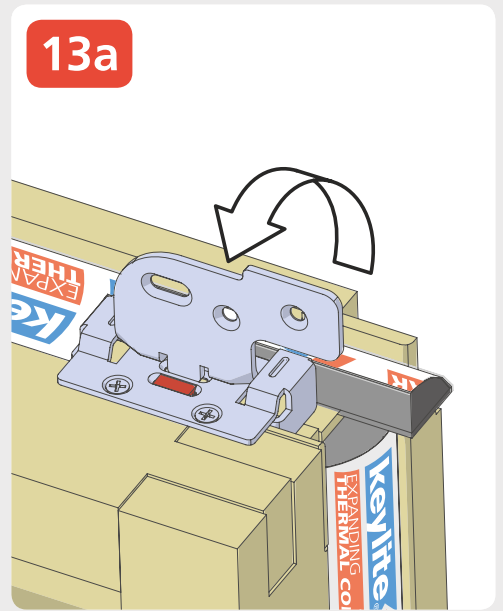
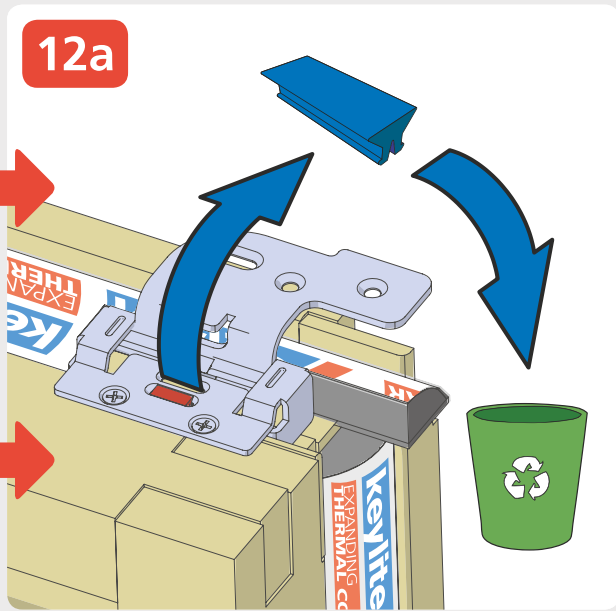
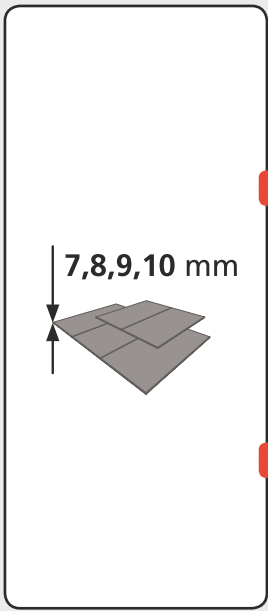

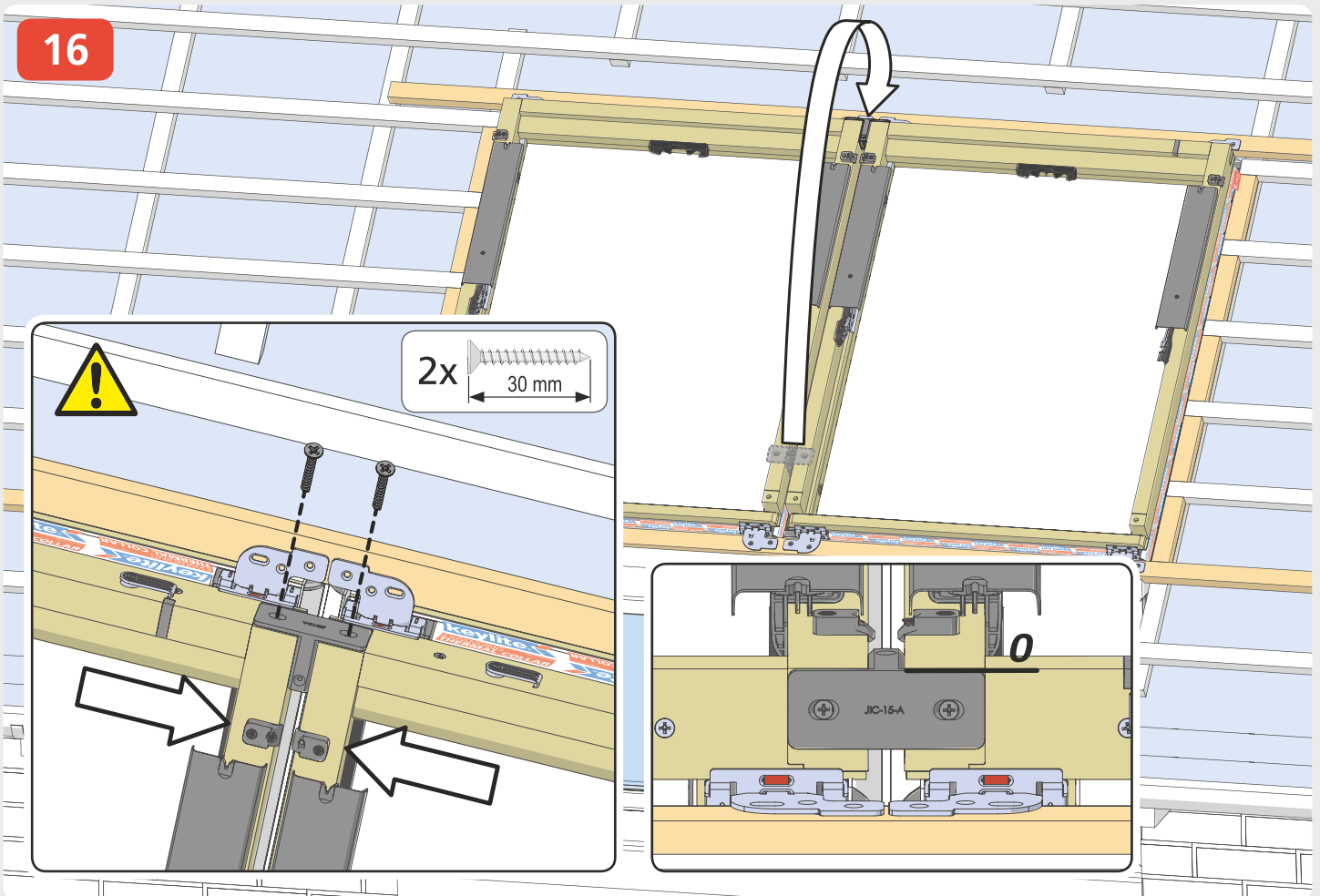
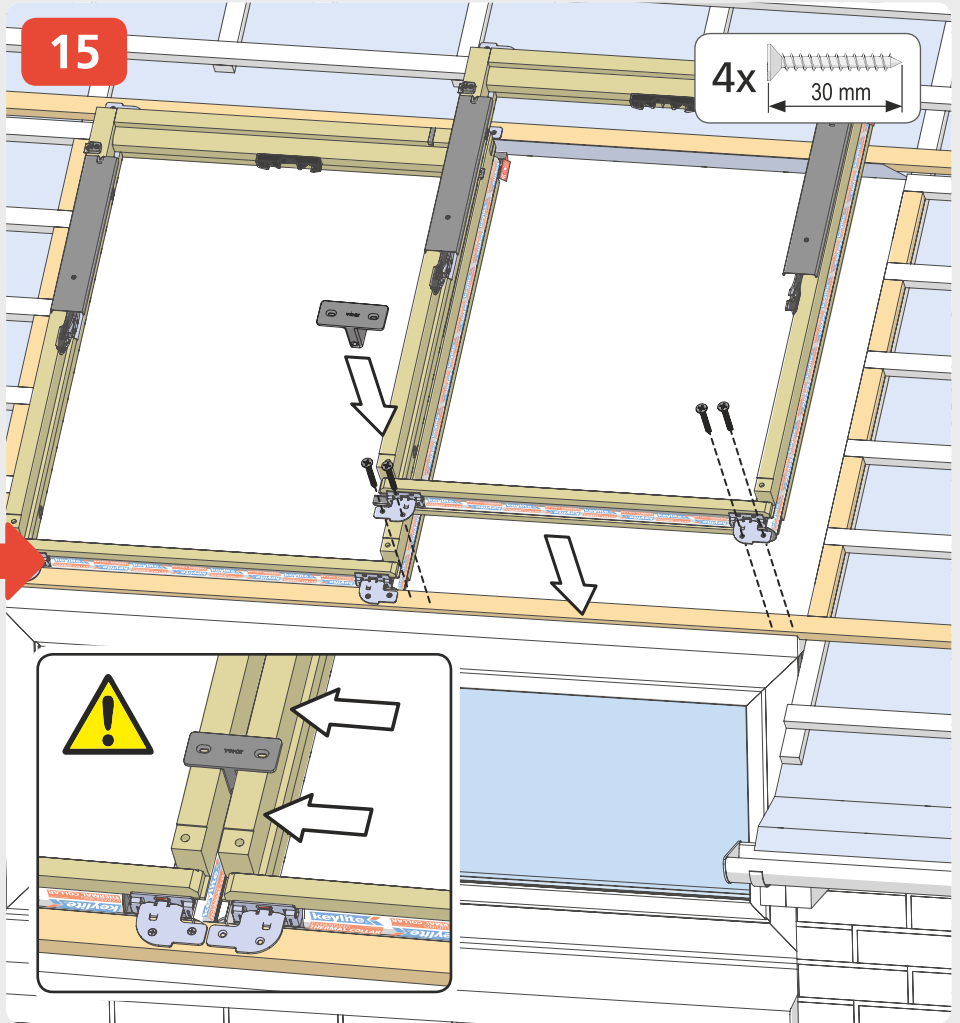
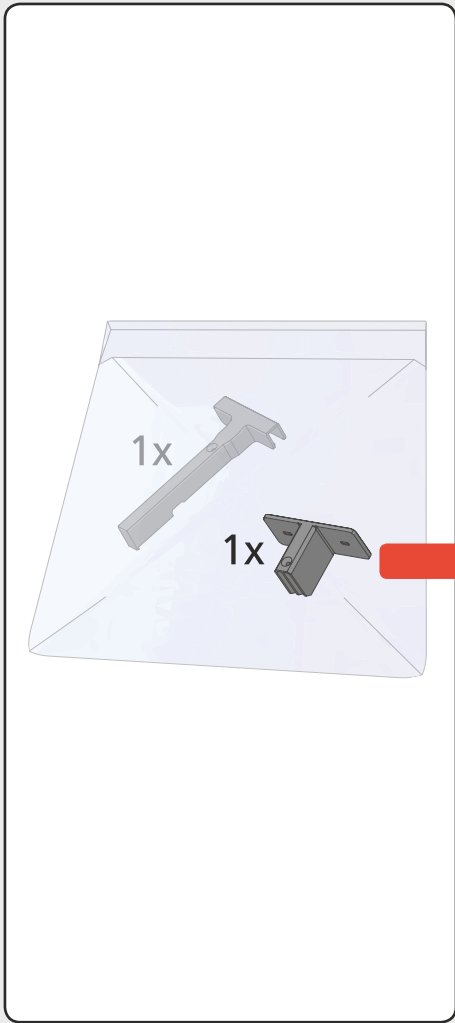

17

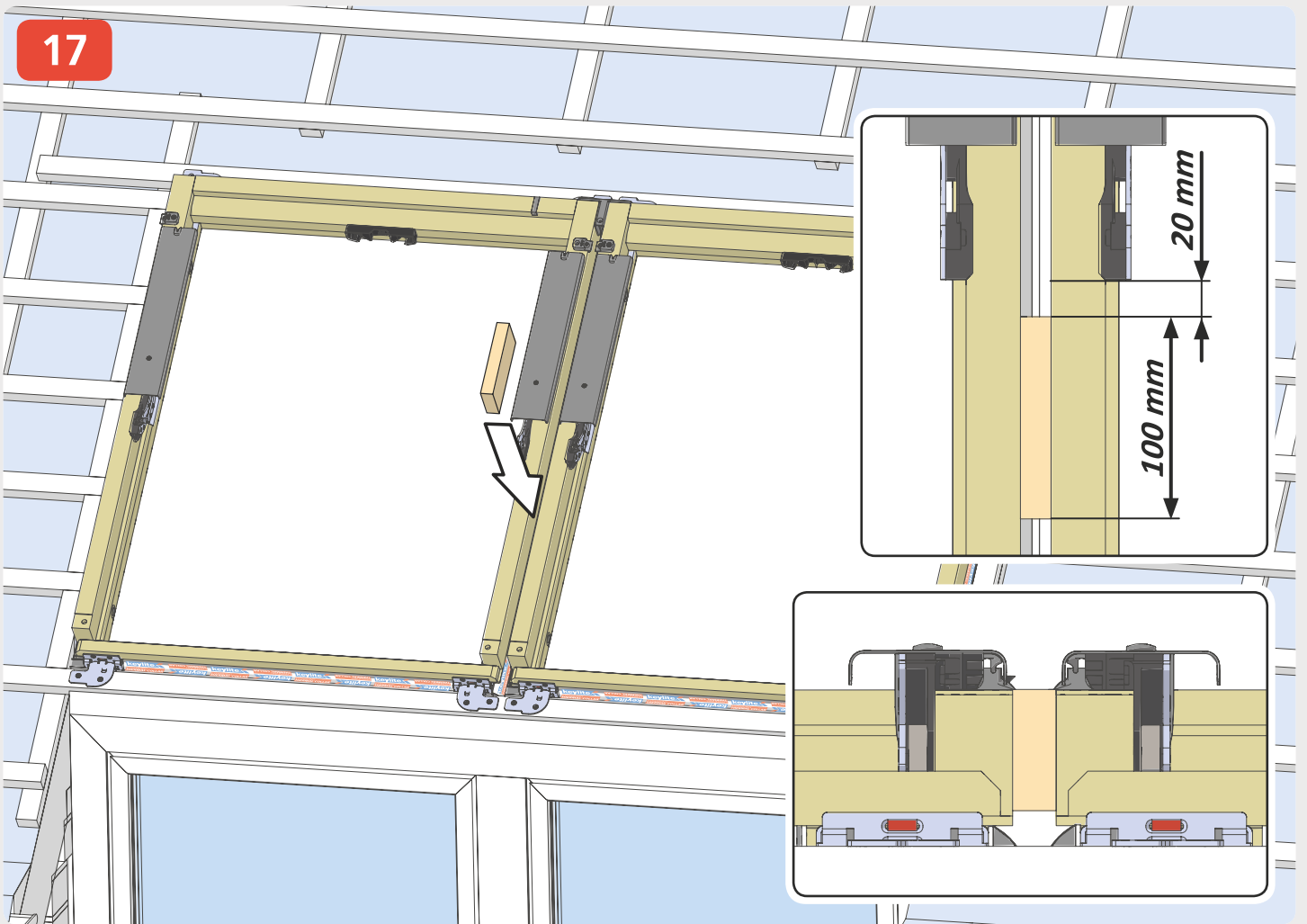

18

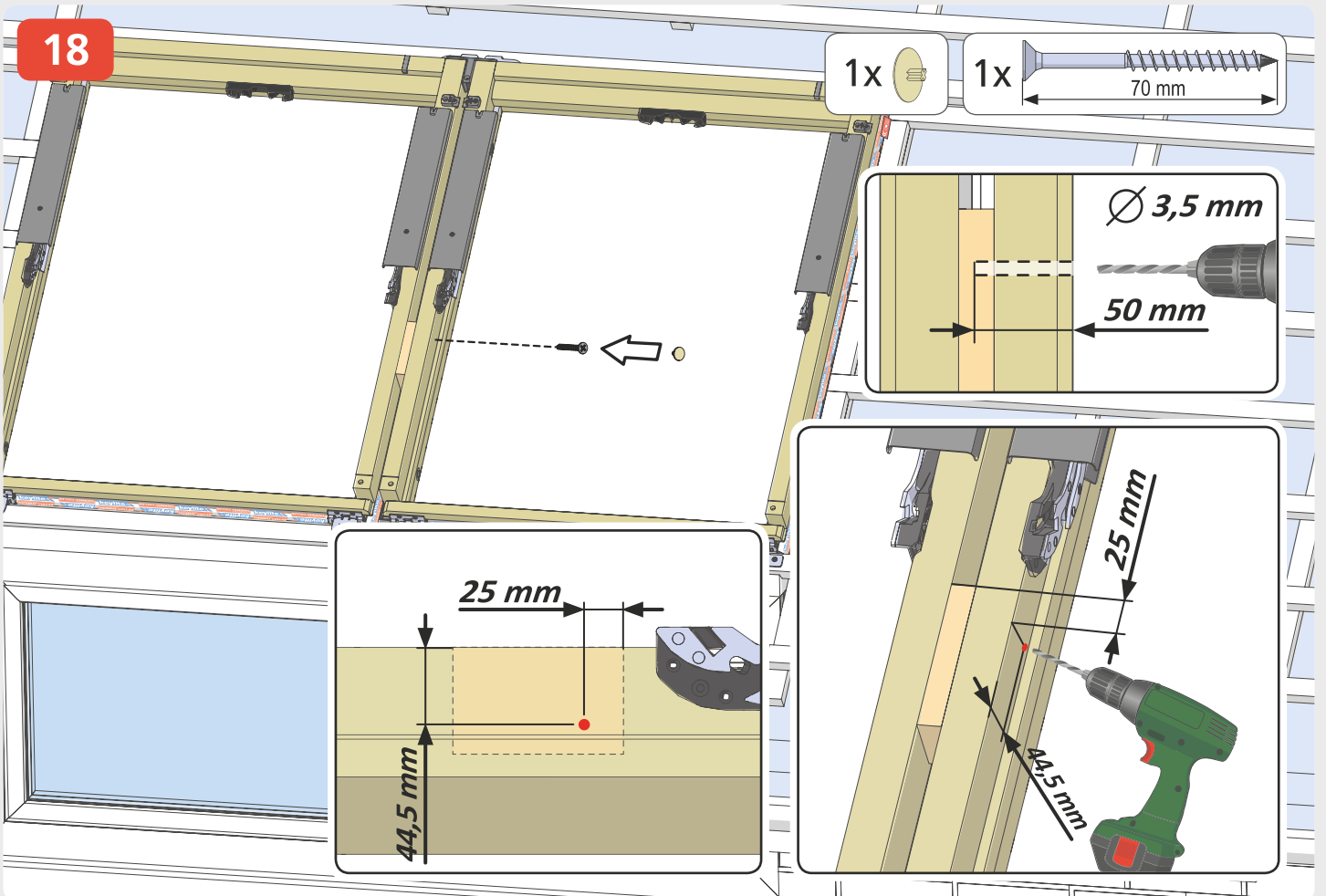

19

1x



1x

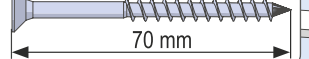

70 mm

Ø 3,5 mm

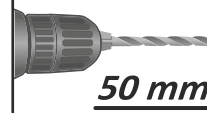

50 mm

25 mm

44,5 mm

44,5 mm

25 mm

20

21

22

23

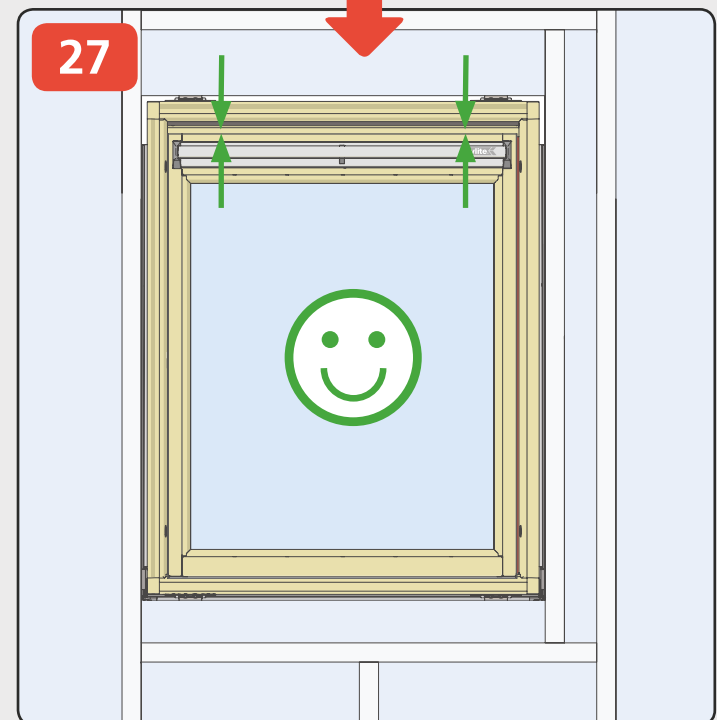
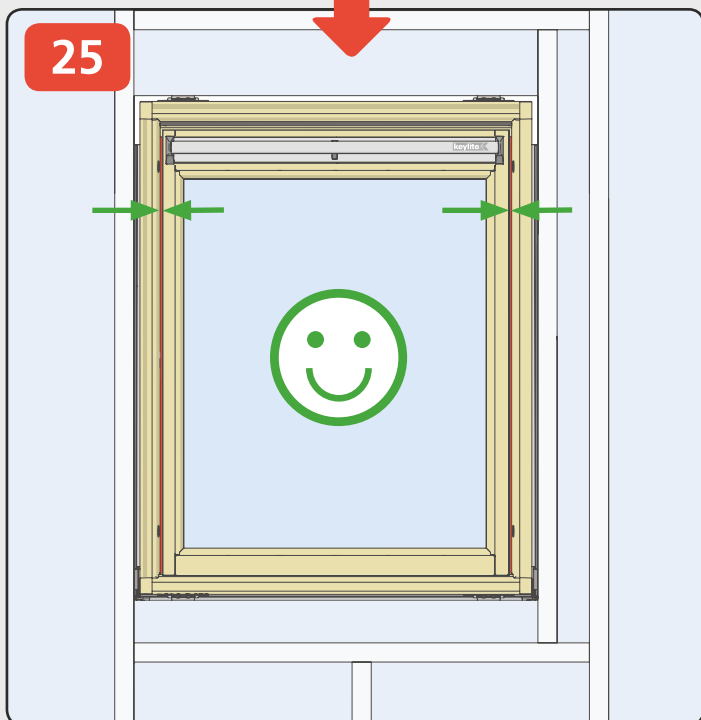
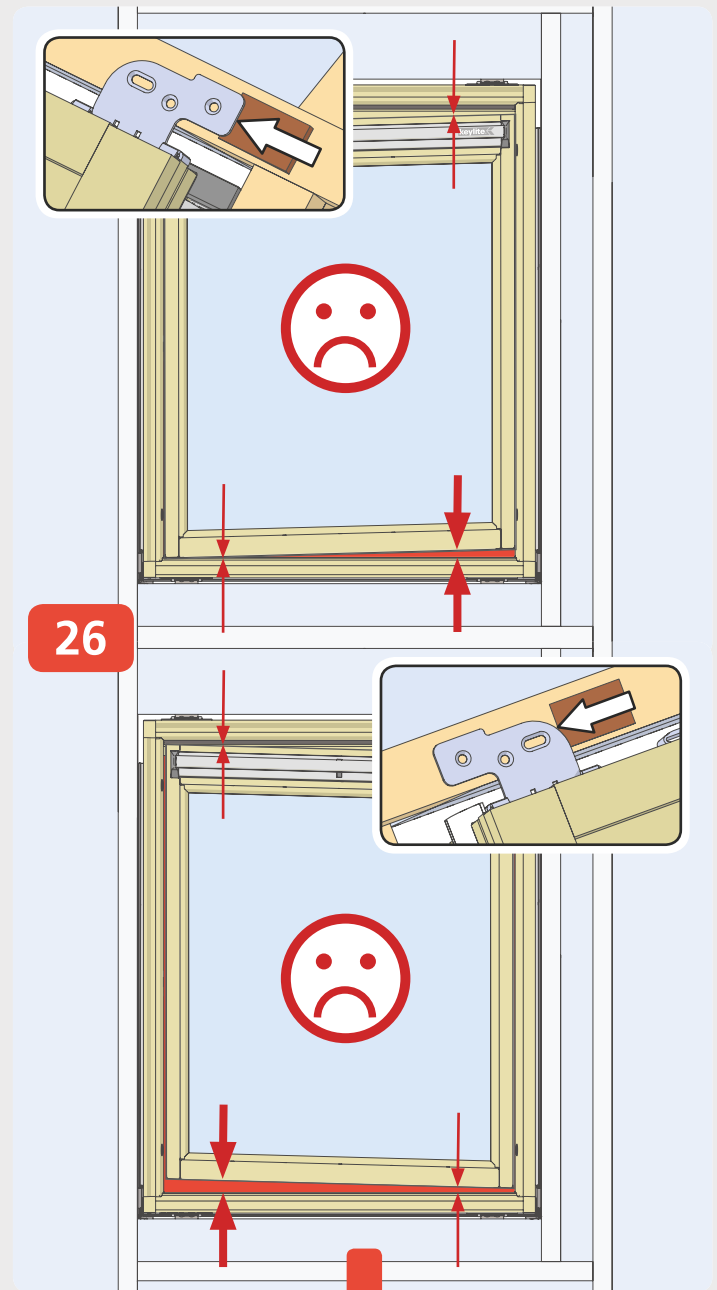
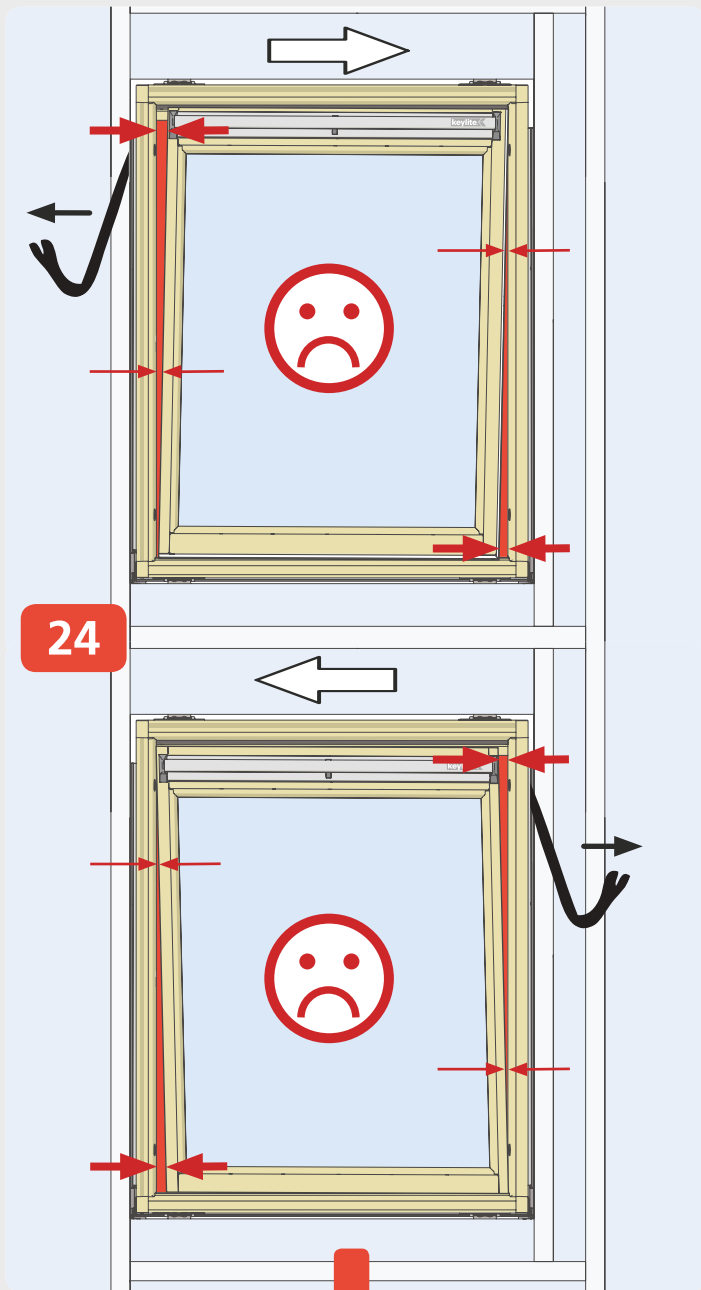

28

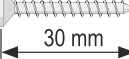
8x 

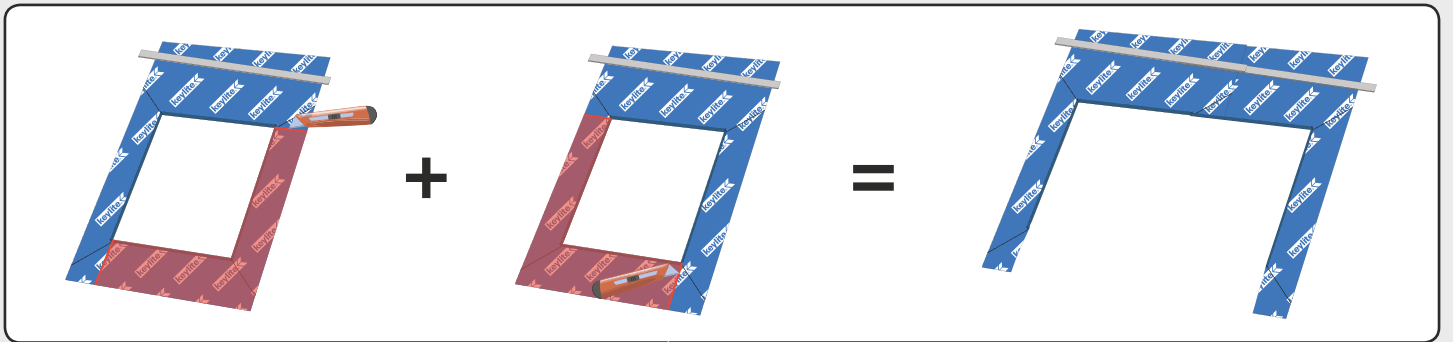
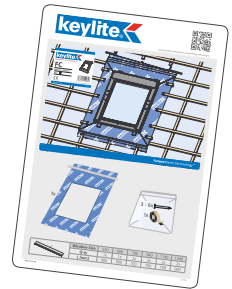
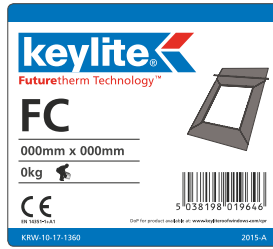
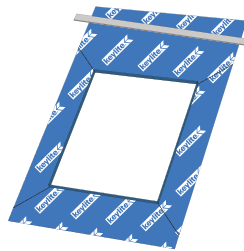
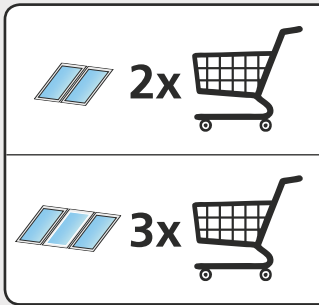
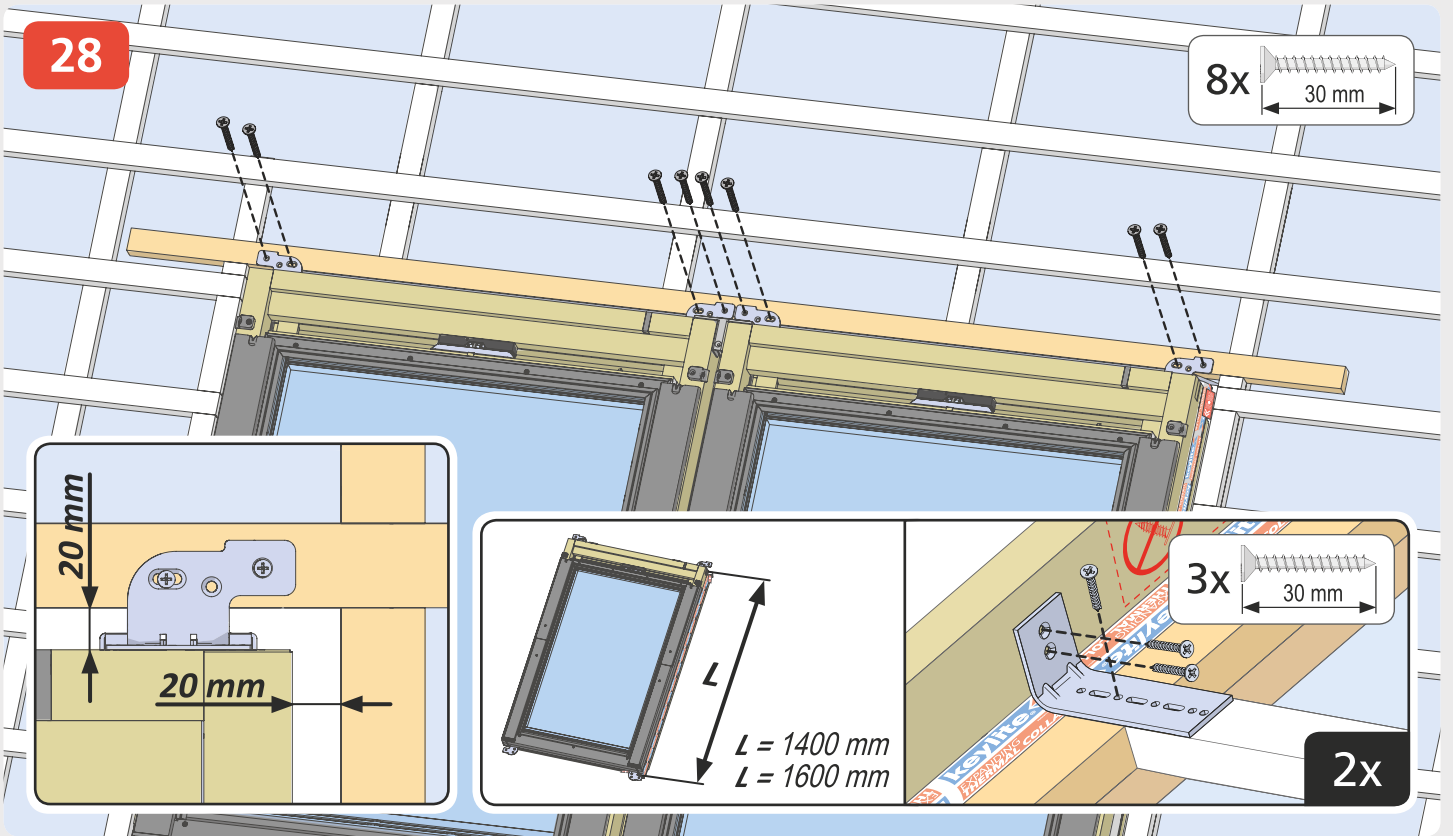

29

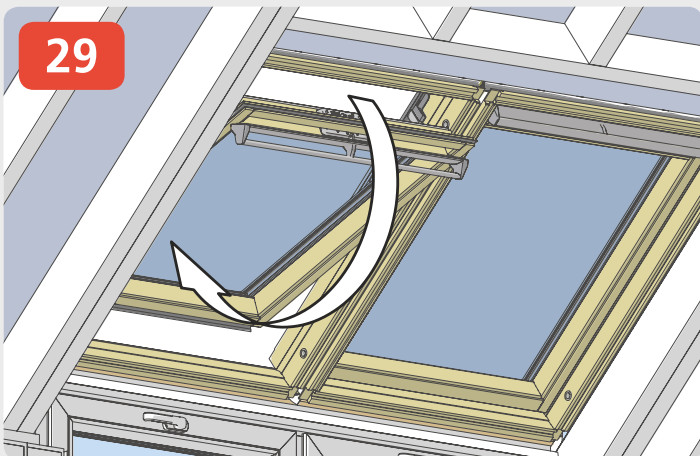

30

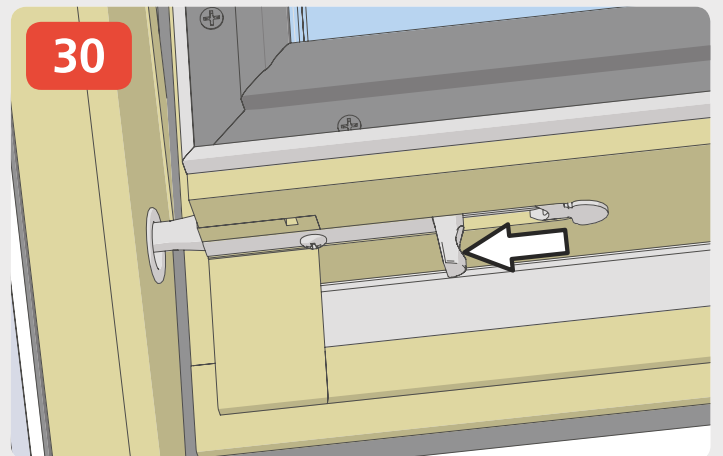

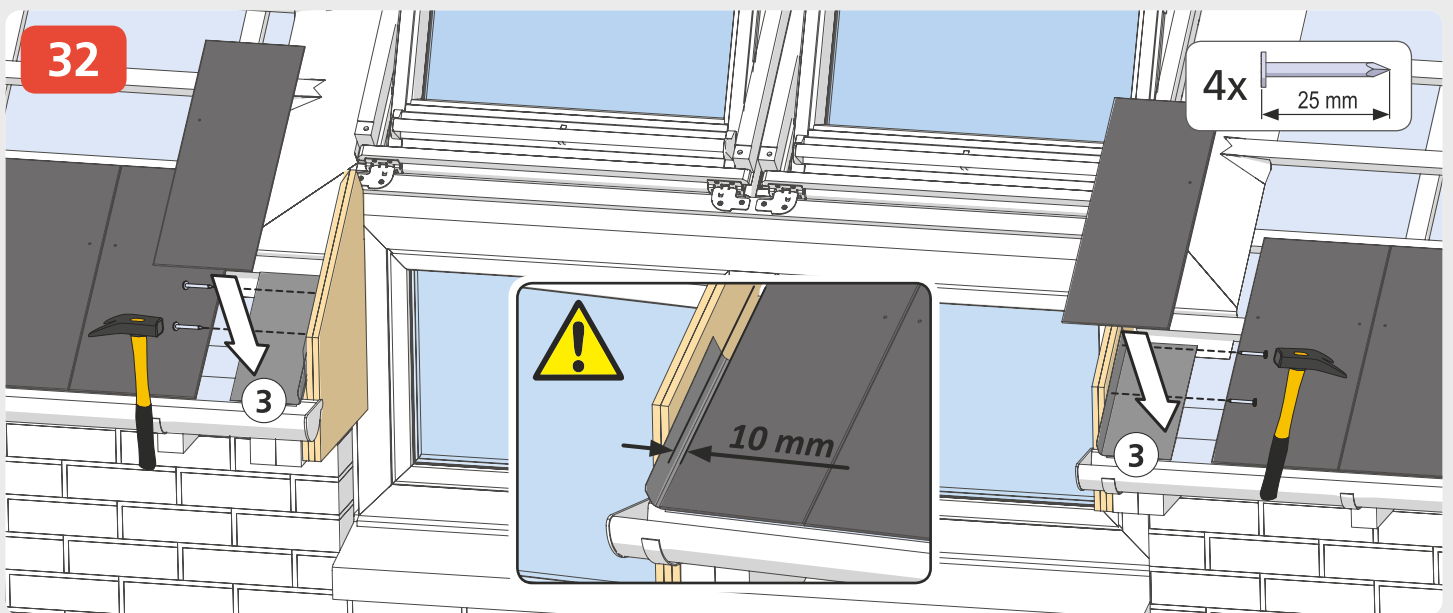
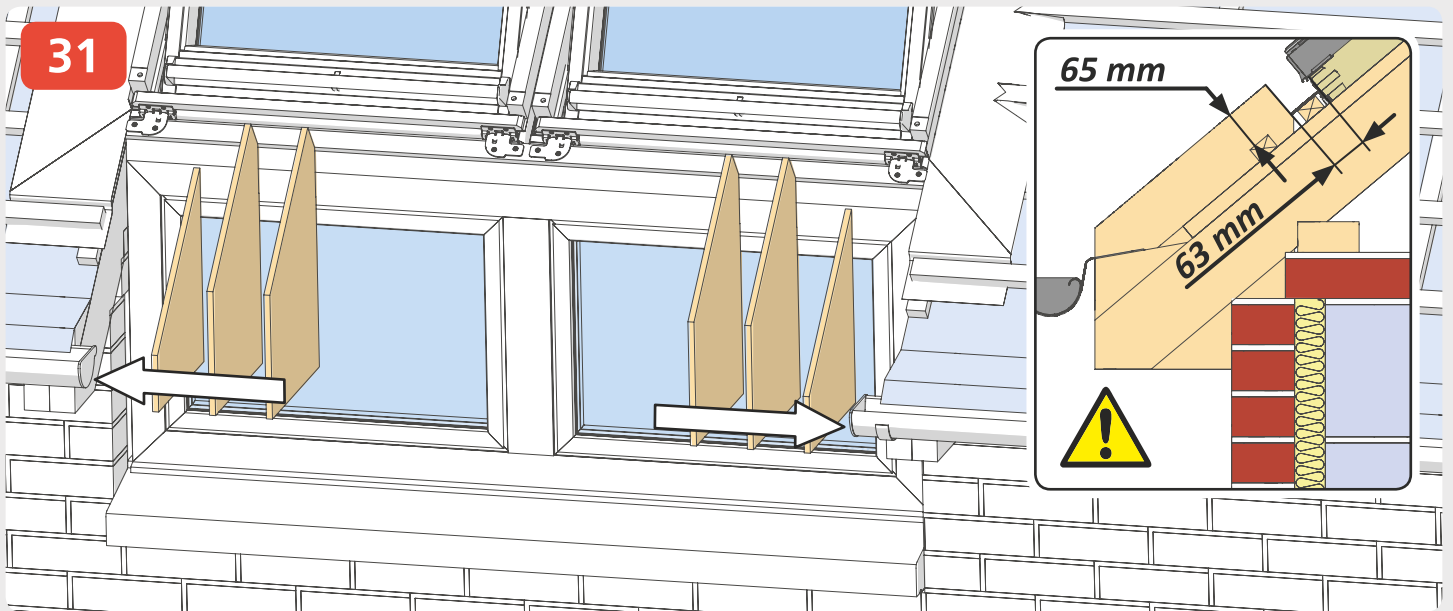

34

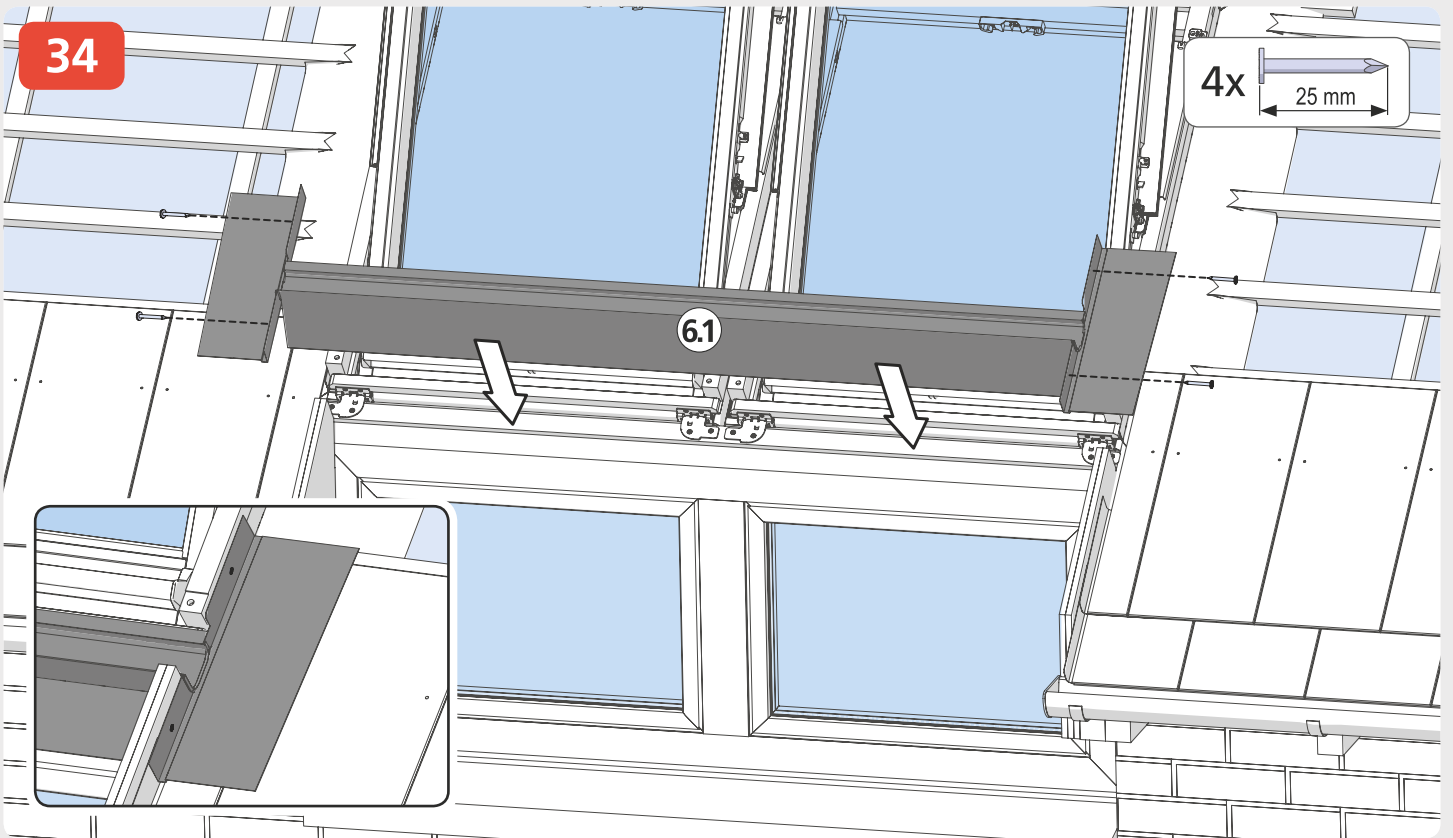

35

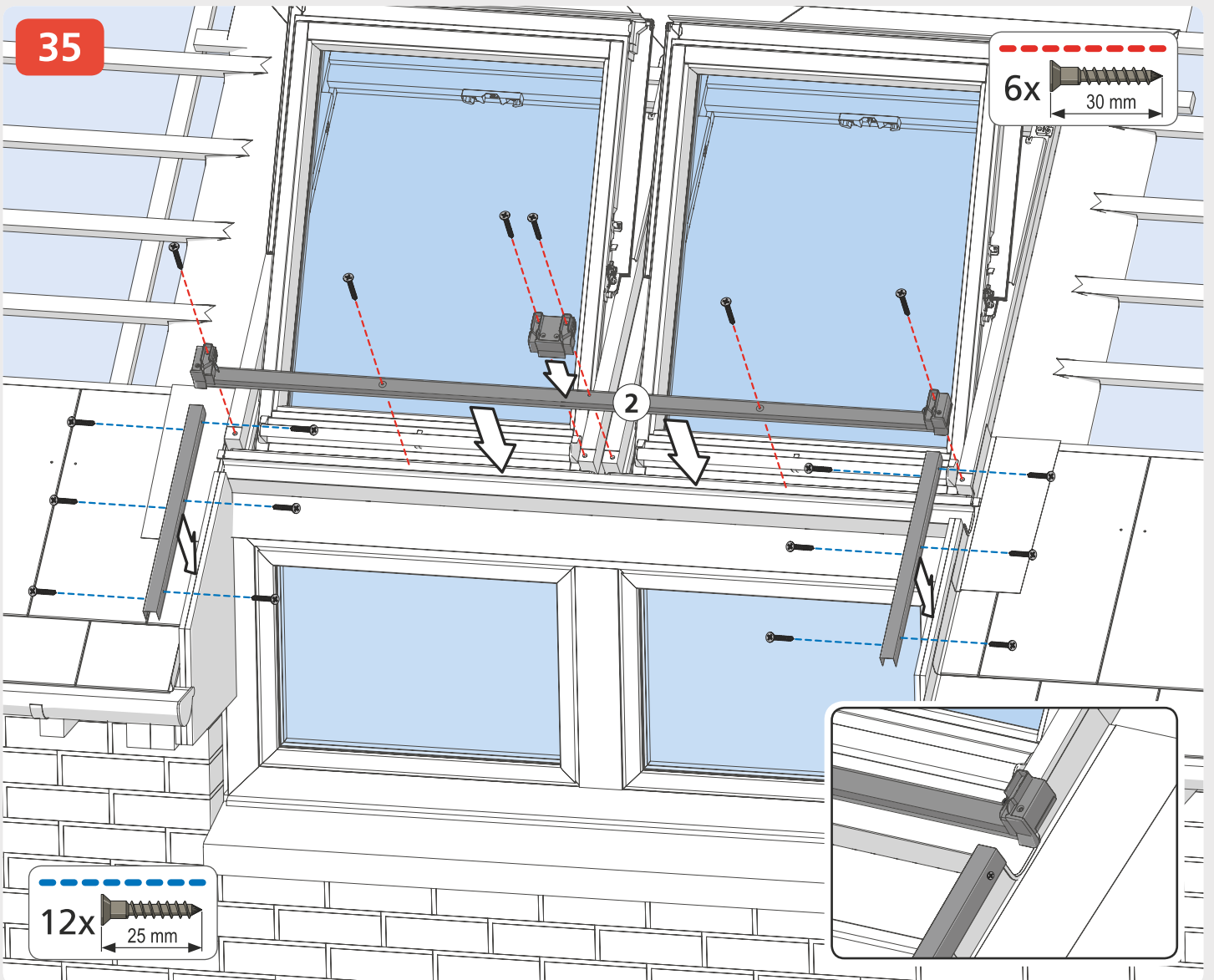

36

2x  30 mm

4.1

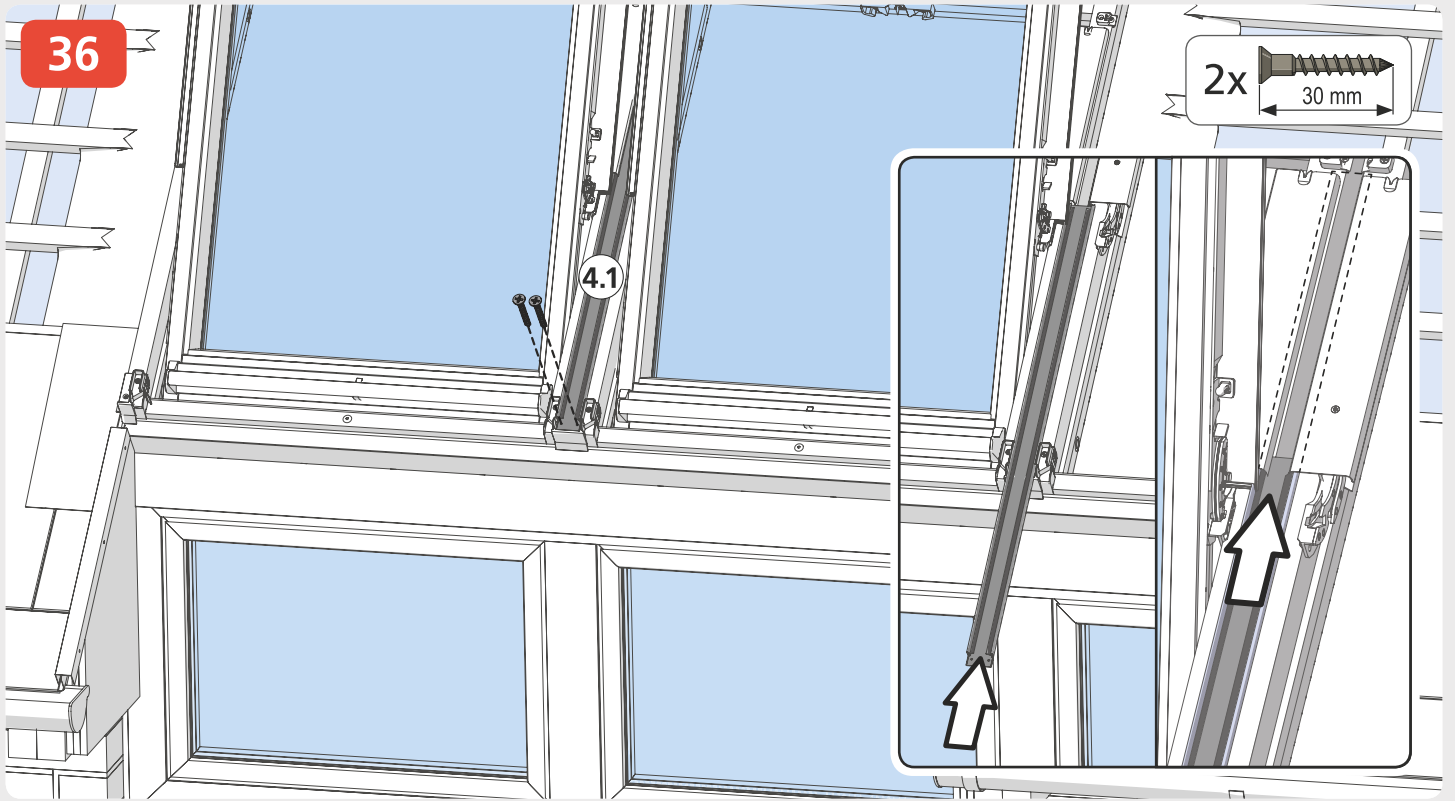

TH/FE

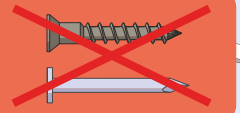
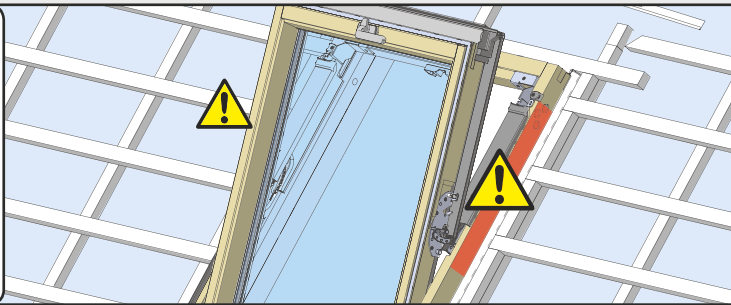

max. 7 mm



37

4x  25 mm

3

3

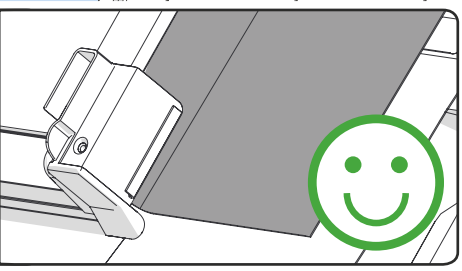
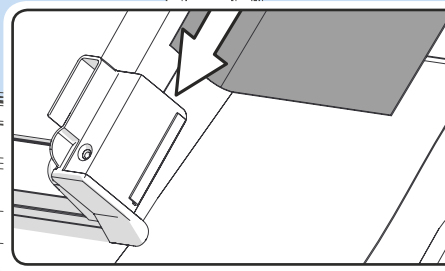
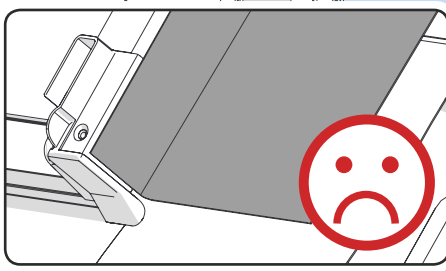
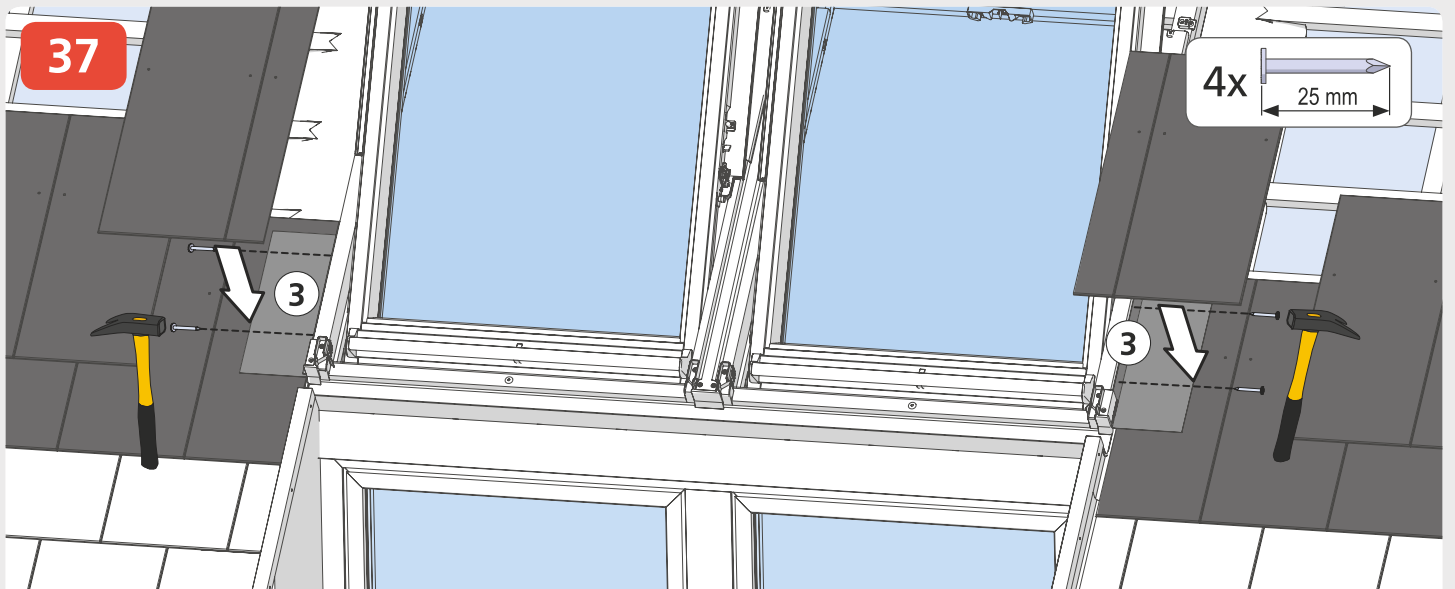

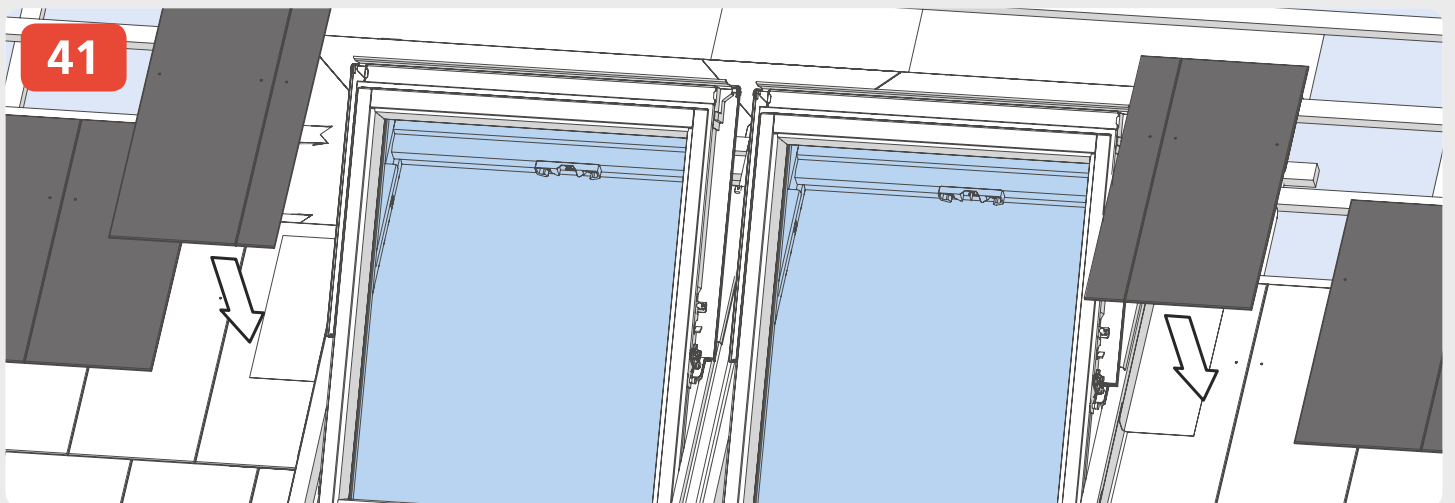
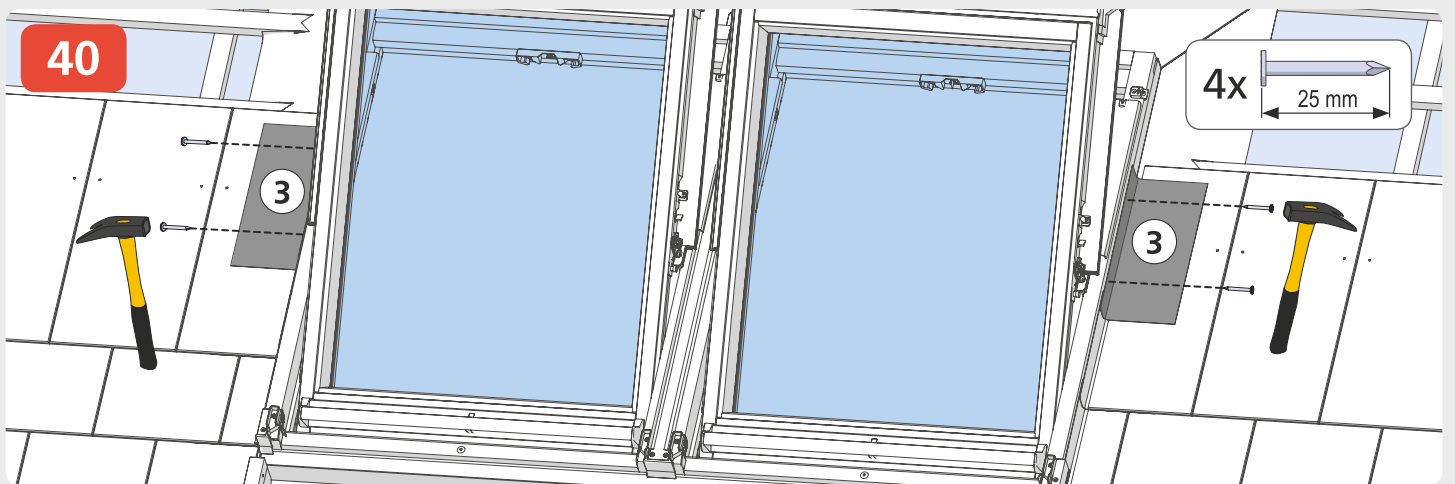
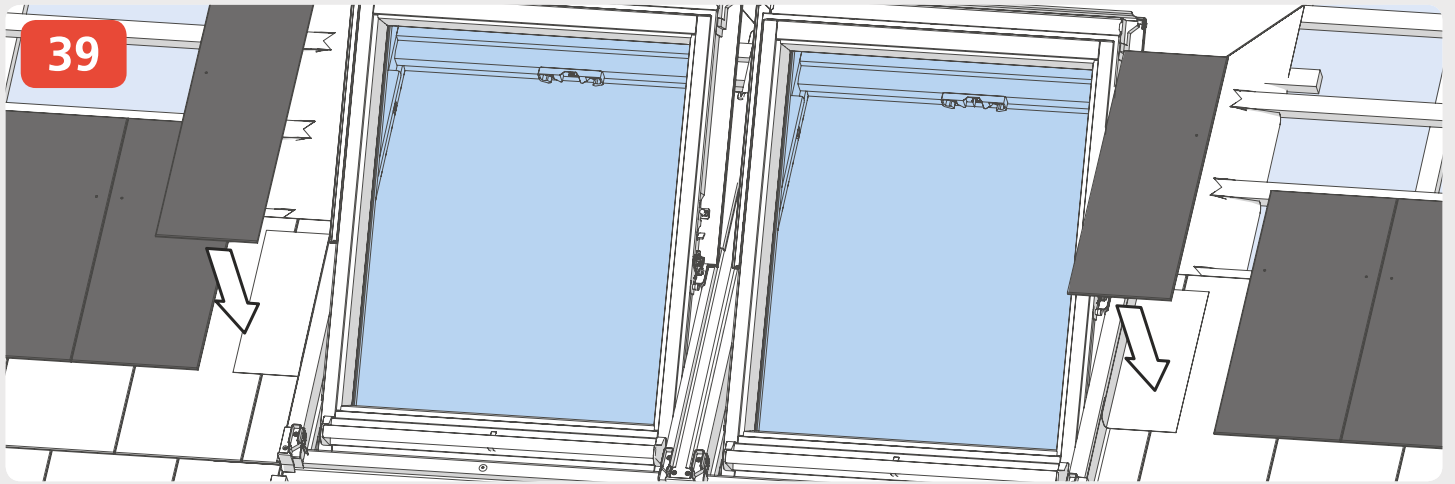
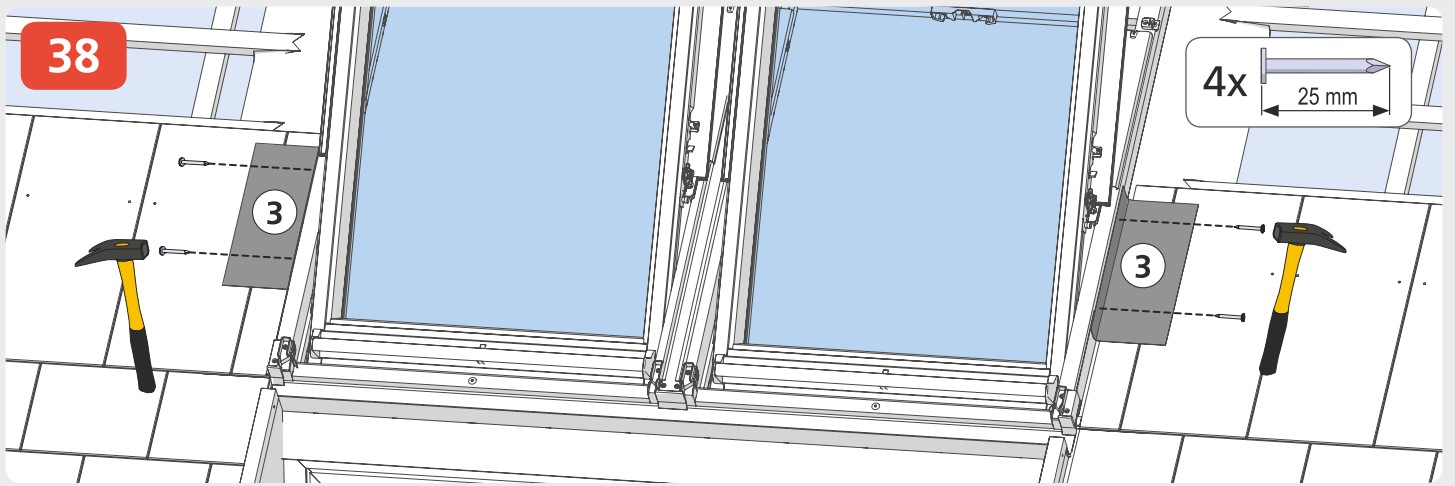

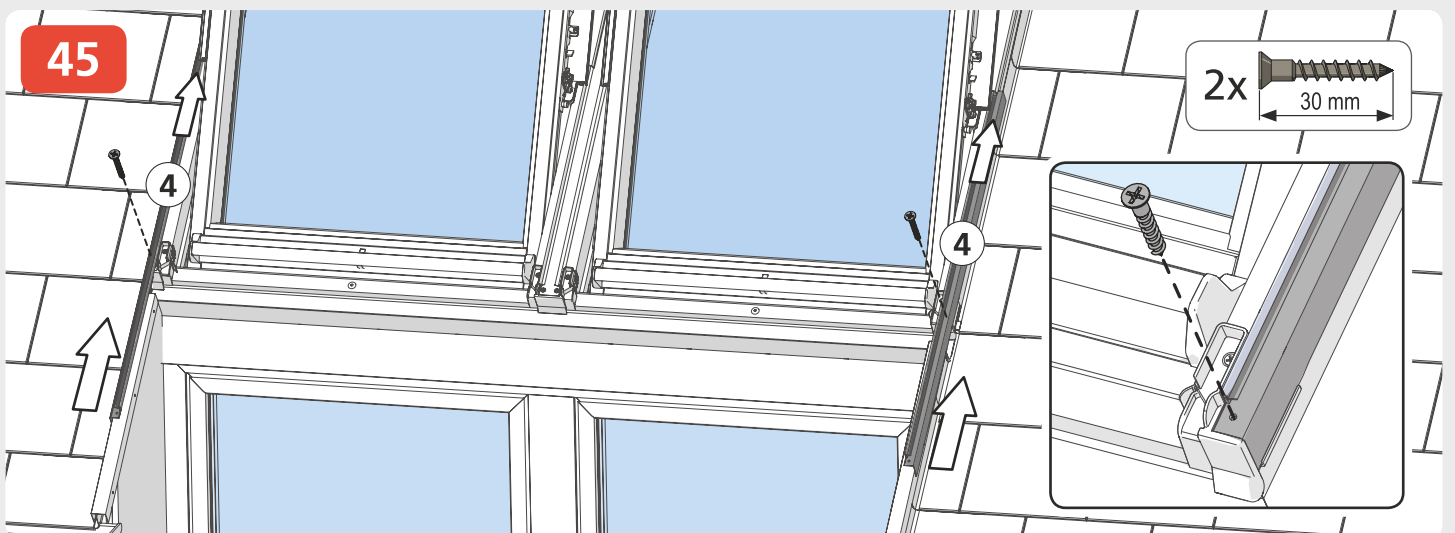
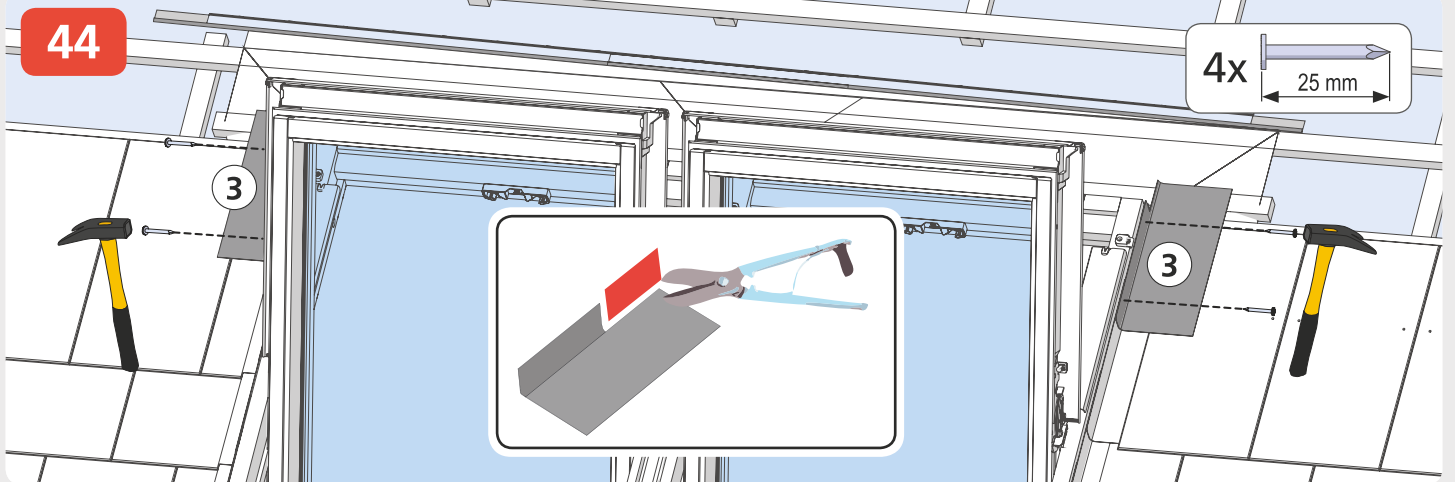
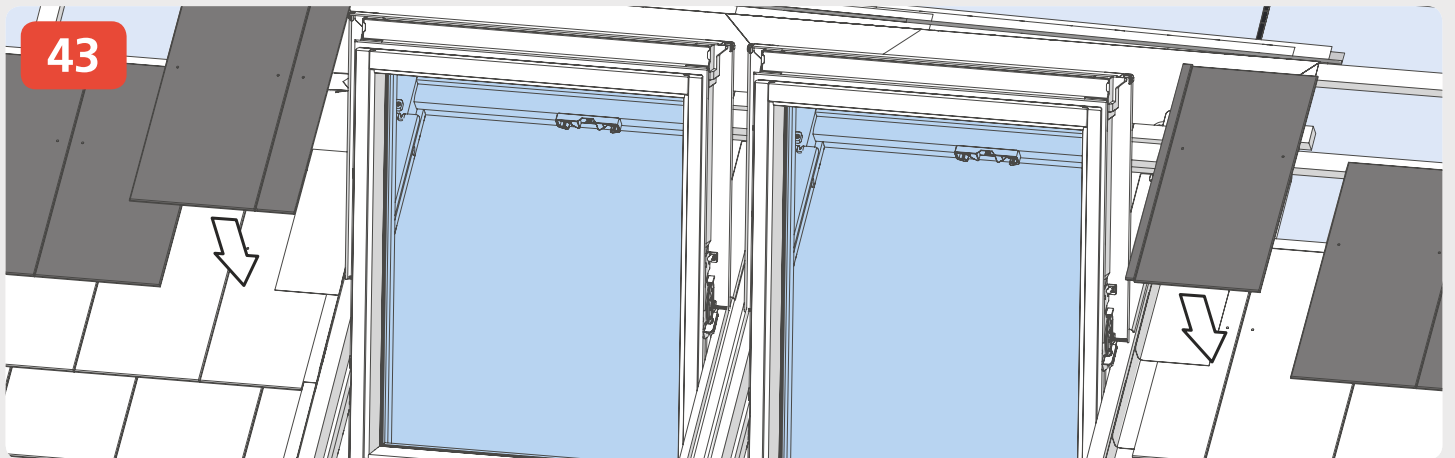
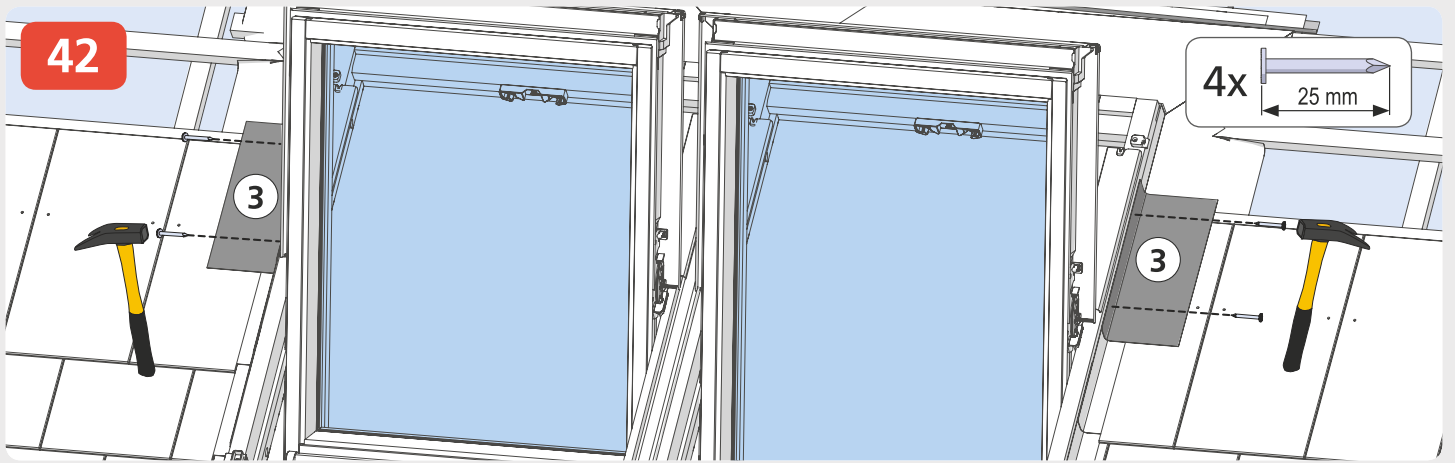

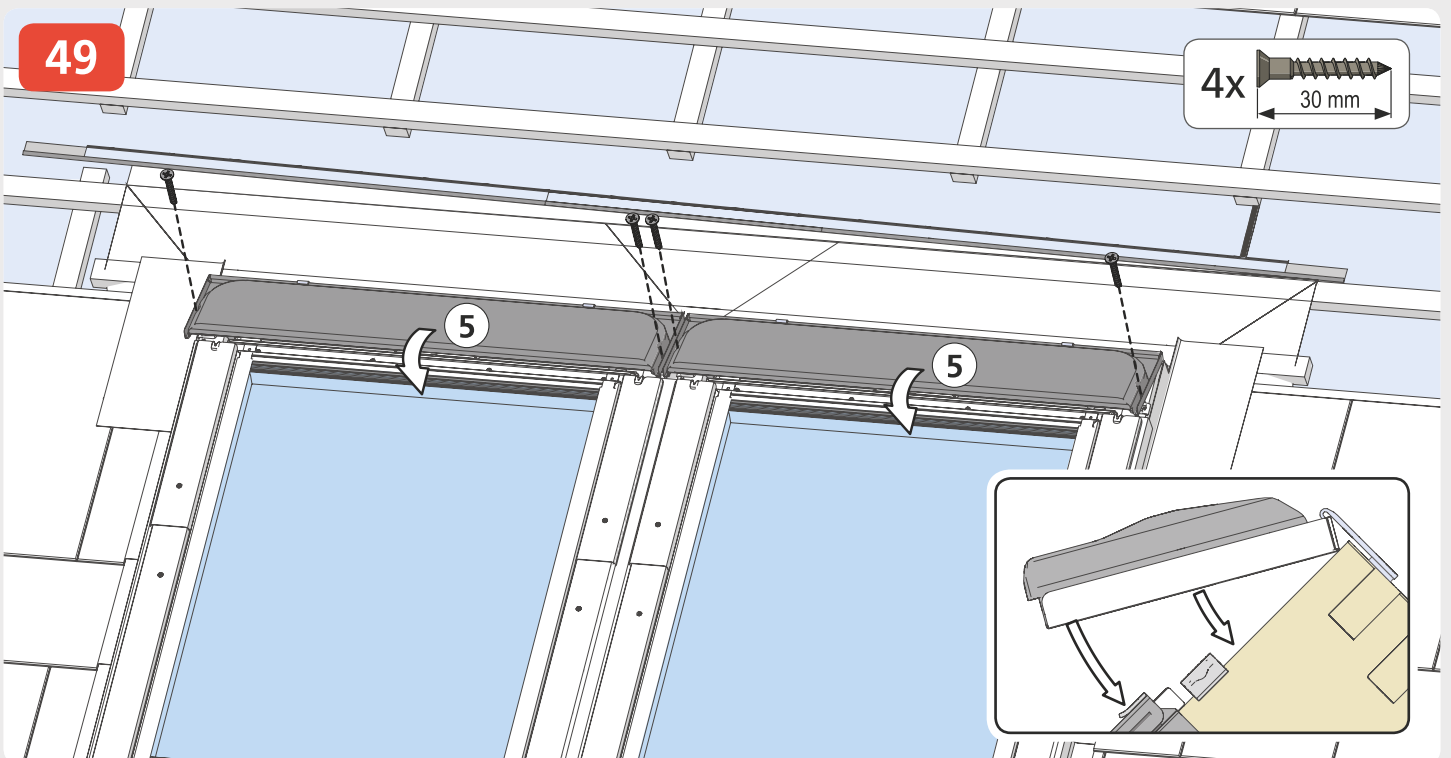
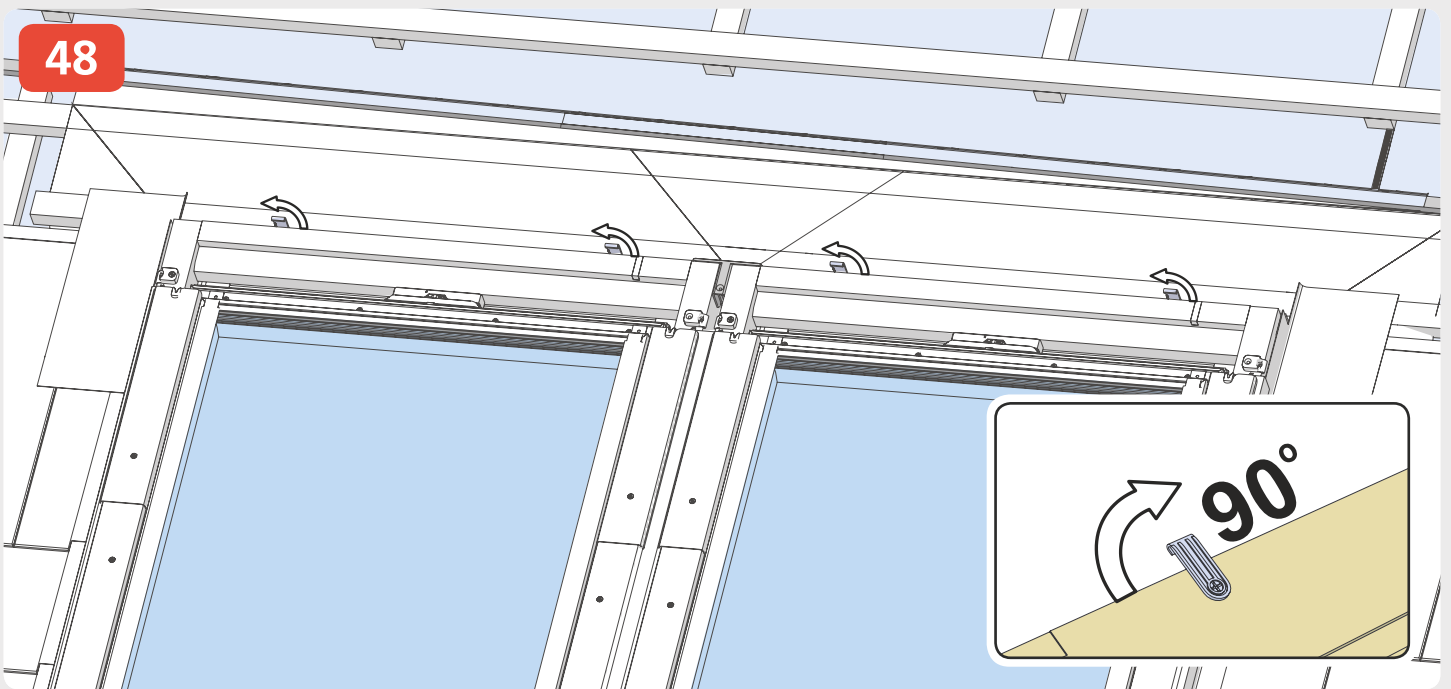
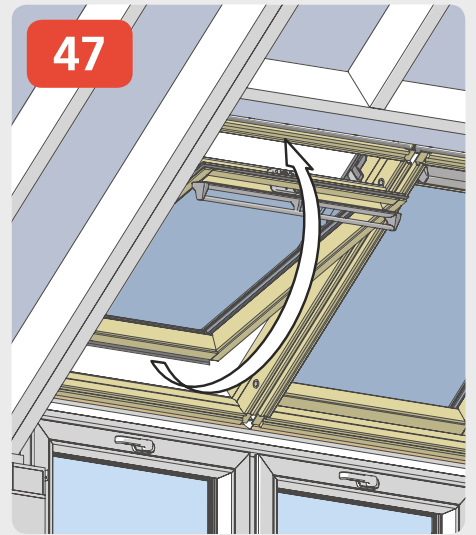
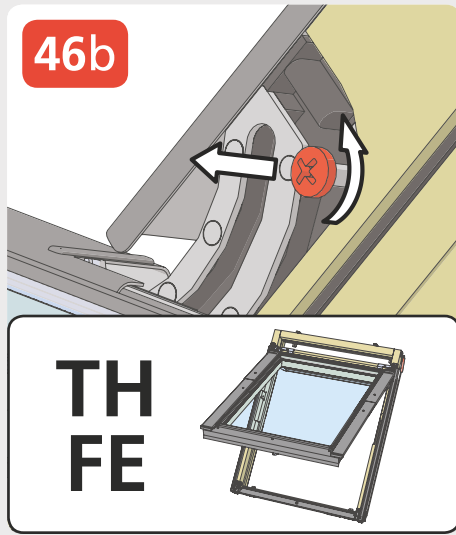
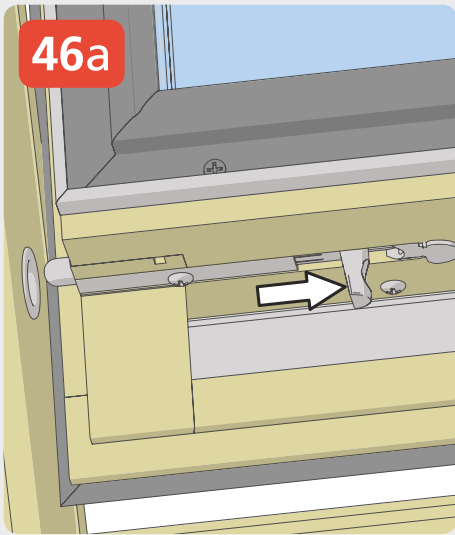

50

2x 30 mm

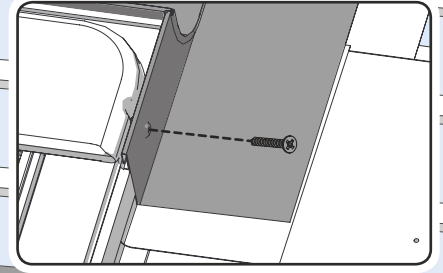

6

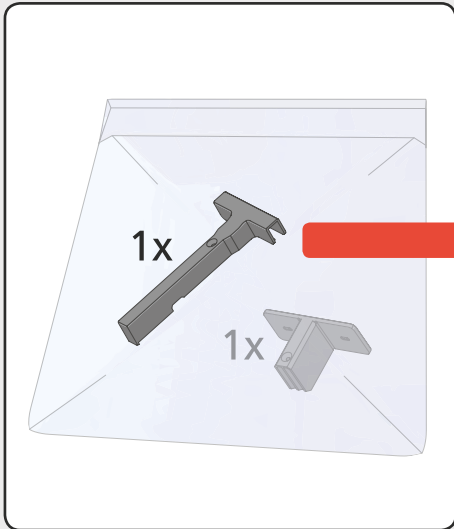

51

1x 60 mm

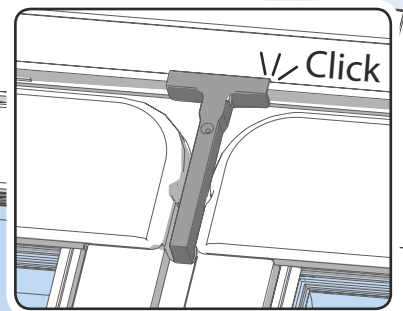

52

60-150mm

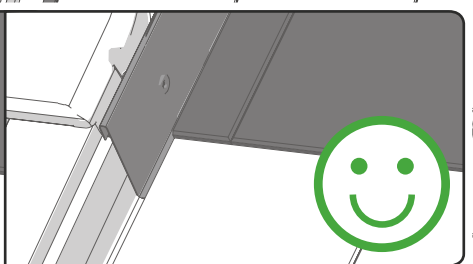
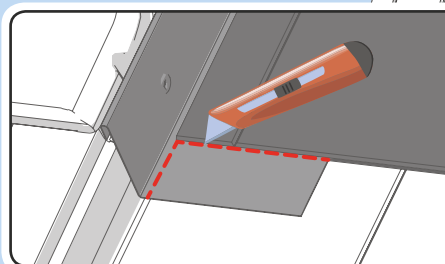
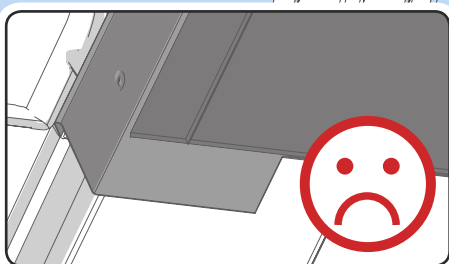

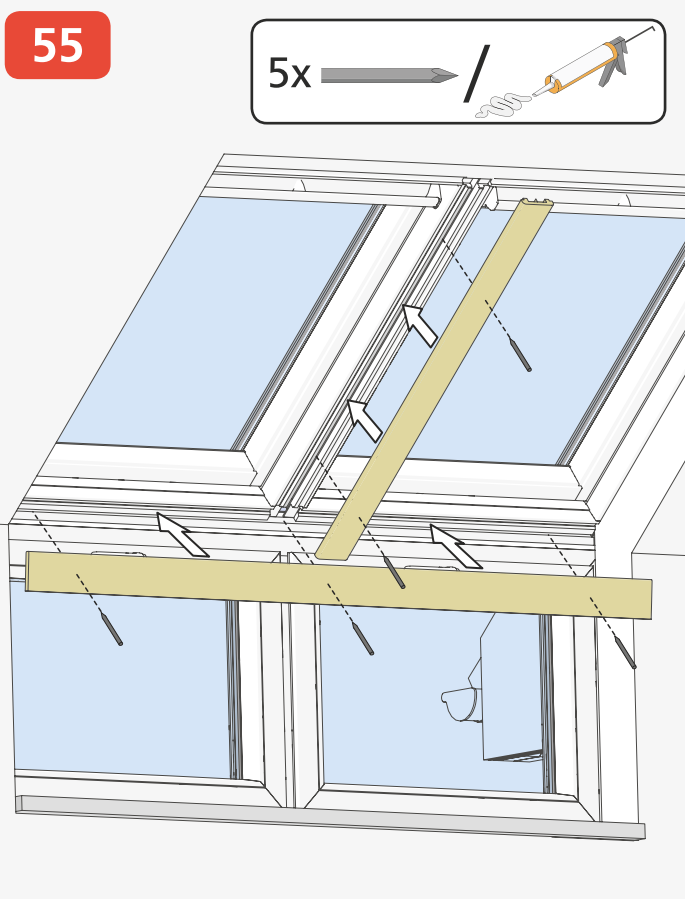
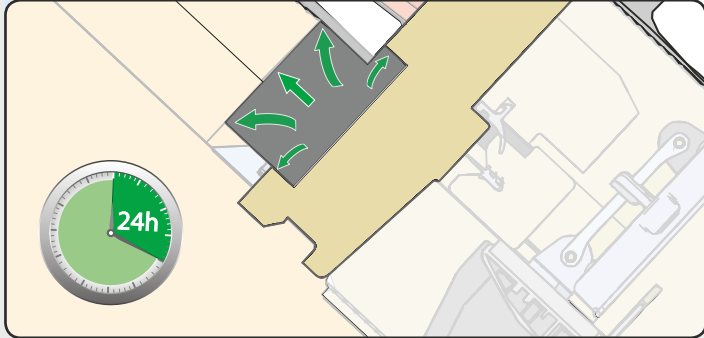
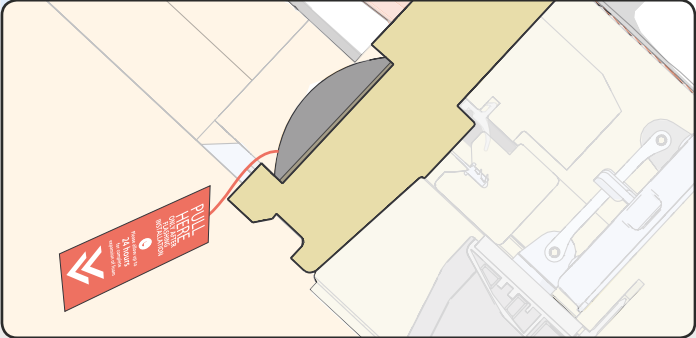
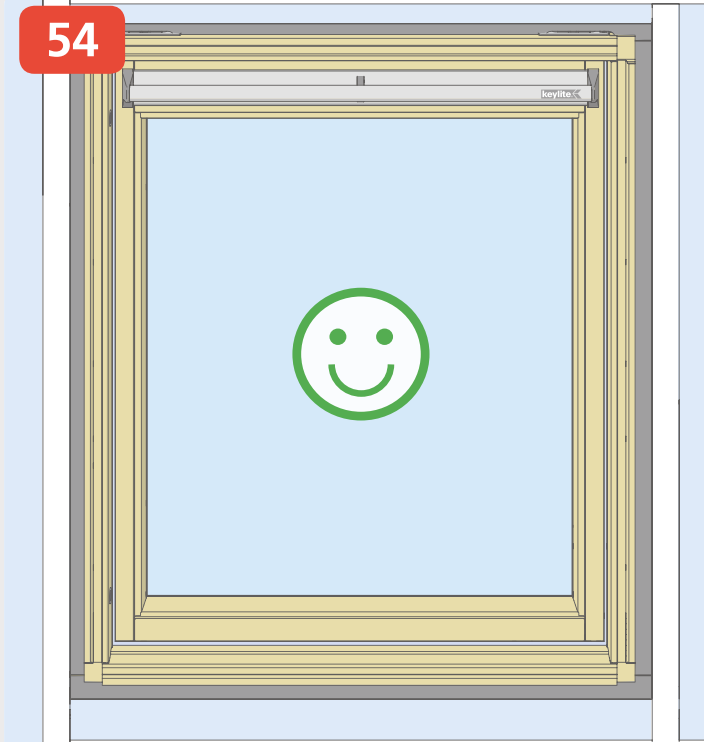
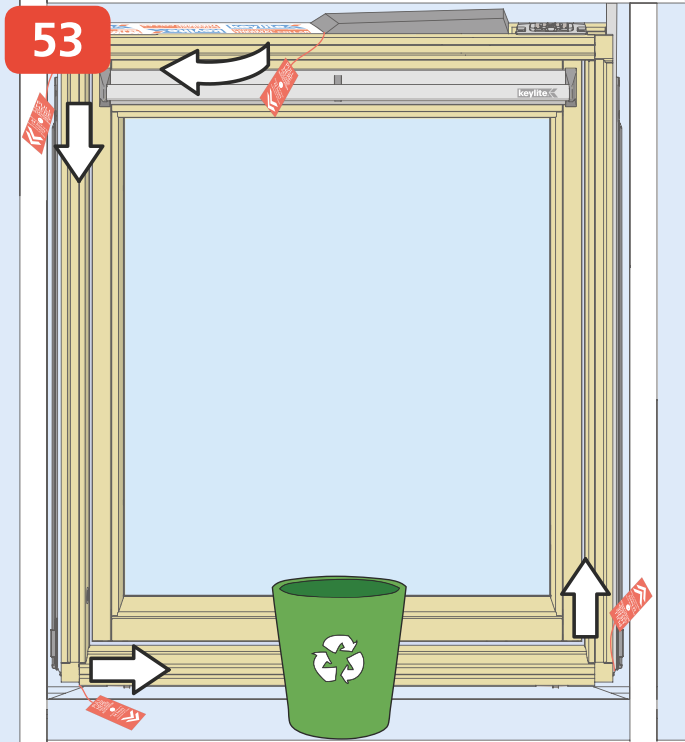



www.keyliteroofwindows.com